

BO 480/481 610

Built-in oven

Table of Contents

Safety Definitions	3	Timer functions	17
IMPORTANT SAFETY INSTRUCTIONS	4	Launching the timer menu	17
Proper Installation and Maintenance	4	Timer	17
Fire Safety	4	Stopwatch	18
Burn Prevention	5	Cooking time	19
Child Safety	6	End of cooking time	19
Cleaning Safety	6	Sabbath mode and Yom Tov mode	20
Cookware Safety	6	Sabbath mode	20
State of California Proposition 65 Warnings	6	Yom Tov mode	21
Causes of damage	7	Personal recipes	22
Protecting the environment	7	Recording a recipe	22
Tips for saving energy	7	Programming a recipe	22
Getting to know the appliance	8	Entering a name	23
Oven	8	Starting a recipe	23
Displays and controls	9	Deleting a recipe	23
Symbols	9	Core temperature probe	24
Colors and display	10	Insert the core temperature probe in the	24
Automatic door opening	10	food to be cooked	24
Additional information i and i [®]	10	Setting the core temperature	24
Cooling fan	10	Core temperature guidelines	25
Program selection positions	11	Rotisserie spit	26
Accessories	13	Preparation	27
Special accessories	13	Switching on the rotisserie spit	27
Before first use	14	Switching off the rotisserie spit	27
Setting the language	14	Roasting function	28
Setting the time format	14	Child lock	28
Setting the time	14	Activating the child lock	28
Setting the date format	14	Deactivating the child lock	28
Setting the date	15	Factory setting	29
Setting the temperature format	15	Cleaning and maintenance	31
Completing initial set-up	15	Cleaning agents	31
Heating up the oven	15	Removing slide-in racks	32
Cleaning accessories	15	Self-clean (pyrolysis)	32
Activating the appliance	16	Preparing self-clean (pyrolysis)	33
Standby	16	Starting self-clean (pyrolysis)	33
Activate appliance	16	Cleaning accessories with self-clean (pyrolysis)	33
Operating the appliance	16	Troubleshooting	34
Oven interior	16	Power cut	34
Inserting accessories	16	Demo mode	34
Turning on	17	Replacing the oven lamp	35
Quick heat	17		
Safety lock	17		

Customer service	35
-------------------------	-----------

Tables and tips	36
Baking table	36
Baking tips and tricks	37
Roasting table	38
Roasting tips and tricks	39
Grilling table	40
Thawing	41
Acrylamide in foodstuffs	41

Additional information on products, accessories, replacement parts and services can be found at www.gaggenau.com and in the online shop www.gaggenau-eshop.com

Safety Definitions

WARNING

This indicates that death or serious injuries may occur as a result of non-observance of this warning.

CAUTION

This indicates that minor or moderate injuries may occur as a result of non-observance of this warning.

NOTICE: This indicates that damage to the appliance or property may occur as a result of non-compliance with this advisory.

Note: This alerts you to important information and/or tips.



IMPORTANT SAFETY INSTRUCTIONS

READ AND SAVE THESE INSTRUCTIONS

WARNING

When properly cared for, your new appliance has been designed to be safe and reliable. Read all instructions carefully before use. These precautions will reduce the risk of burns, electric shock, fire, and injury to persons. When using kitchen appliances, basic safety precautions must be followed, including those in the following pages.

Proper Installation and Maintenance

Have the installer show you the location of the circuit breaker or fuse. Mark it for easy reference.

This appliance must be properly installed and grounded by a qualified technician. Connect only to properly grounded outlet. Refer to Installation Instructions for details.

This appliance is intended for normal family household use only. It is not approved for outdoor use. See the Warranty. If you have any questions, contact the manufacturer.

Do not store or use corrosive chemicals, vapors, flammables or nonfood products in or near this appliance. It is specifically designed for use when heating or cooking food. The use of corrosive chemicals in heating or cleaning will damage the appliance and could result in injury.

Do not operate this appliance if it is not working properly, or if it has been damaged. Contact an authorized servicer.

Do not obstruct oven vents.

Do not repair or replace any part of the appliance unless specifically recommended in this manual. Refer all servicing to a factory authorized service center.

In the event of an error the display flashes and beeps continuously. Disconnect appliance from the power supply and call a qualified technician.

WARNING

When removing the door make sure oven is cool and power to the oven has been turned off before removing the door. Failure to do so could result in burns.

The oven door is heavy and fragile. Use both hands to remove the oven door. The door front is glass. Handle carefully to avoid breaking.

Grasp only the sides of the oven door. Do not grasp the handle as it may swing in your hand and cause injury or damage.

Failure to grasp the oven door firmly and properly could result in personal injury or product damage.

Lay the door on a flat smooth surface so that the door cannot fall over. Failure to do so may result in personal injury or damage to the appliance.

WARNING

To avoid injury from hinge bracket snapping closed, be sure that both levers are securely in place before removing door. Also, do not force door open or closed - the hinge could be damaged and injury could result.

WARNING

Make sure the appliance and lights are cool and power to the appliance has been turned off before replacing the light bulb(s). Failure to do so could result in electrical shock or burns. The lenses (if equipped) must be in place when using the appliance. The lenses (if equipped) serve to protect the light bulb from breaking. The lenses (if equipped) are made of glass. Handle carefully to avoid breaking. Broken glass can cause an injury.

WARNING

Light socket is live when door is open if main power supply is not turned off.

Fire Safety

WARNING

NEVER cover any slots, holes or passages in the oven bottom or cover an entire rack with materials such as aluminum foil. Doing so blocks air flow through the oven. Aluminum foil linings may also trap heat, causing a fire hazard.



IMPORTANT SAFETY INSTRUCTIONS

READ AND SAVE THESE INSTRUCTIONS

If materials inside an oven or warming drawer should ignite, keep door closed. Turn off the appliance and disconnect the circuit at the circuit breaker box.

WARNING

Use this appliance only for its intended use as described in this manual. NEVER use this appliance as a space heater to heat or warm the room. Doing so may result in overheating the appliance. Never use the appliance for storage.

Always have a working smoke detector near the kitchen.

In the event that personal clothing or hair catches fire, drop and roll immediately to extinguish flames.

Have an appropriate fire extinguisher available, nearby, highly visible and easily accessible near the appliance.

Smother flames from food fires other than grease fires with baking soda. Never use water on cooking fires.

WARNING

TO REDUCE THE RISK OF INJURY TO PERSONS IN THE EVENT OF A GREASE FIRE, OBSERVE THE FOLLOWING:

- a) SMOTHER FLAMES with a close-fitting lid, cookie sheet, or metal tray, then turn off the burner. BE CAREFUL TO PREVENT BURNS. If the flames do not go out immediately, EVACUATE AND CALL THE FIRE DEPARTMENT.
 - b) NEVER PICK UP A FLAMING PAN – You may be burned.
 - c) DO NOT USE WATER, including wet dishcloths or towels – a violent steam explosion will result.
 - d) Use an extinguisher ONLY if:
 - You know you have a Class ABC extinguisher, and you already know how to operate it.
 - The fire is small and contained in the area where it started.
 - The fire department is being called.
 - You can fight the fire with your back to an exit.
-

Burn Prevention

DO NOT TOUCH HEATING ELEMENTS OR INTERIOR SURFACES OF OVEN - Heating elements may be hot even though they are dark in color. Interior surfaces of an oven become hot enough to cause burns. During and after use, do not touch, or let clothing, potholders, or other flammable materials contact heating elements or interior surfaces of oven until they have had sufficient time to cool. Other surfaces of the appliance may become hot enough to cause burns. Among these surfaces are oven vent openings, surfaces near these openings and oven doors.

Exercise caution when opening the appliance. Standing to the side, open the door (or drawer) slowly and slightly to let hot air and/or steam escape. Keep your face clear of the opening and make sure there are no children or pets near the unit. After the release of hot air and/or steam, proceed with your cooking. Keep doors shut unless necessary for cooking or cleaning purposes. Do not leave open doors unattended.

Do not heat or warm unopened food containers. Build-up of pressure may cause the container to burst and cause injury.

Use caution when cooking foods with high alcohol content (e.g. rum, brandy, bourbon) in the oven. Alcohol evaporates at high temperatures. There is a risk of burning as the alcohol vapors may catch fire in the oven. Use only small quantities of alcohol in foods, and open the oven door carefully.

Always place oven racks in desired location while oven is cool. Always use oven mitts, when the oven is warm. If a rack must be moved while oven is hot, do not let potholder contact the heating elements.

CAUTION

To avoid possible injury or damage to the appliance, ensure rack is installed exactly per installation instructions and not backwards or upside down.

Always use dry potholders. Moist or damp potholders on hot surfaces may result in burns from steam. Do not let potholder touch hot heating elements. Do not use a towel or other bulky cloth.

Secure all loose garments, etc. before beginning. Tie long hair so that it does not hang loose, and do not wear loose fitting clothing or hanging garments, such as ties, scarves, jewelry, or dangling sleeves.



IMPORTANT SAFETY INSTRUCTIONS

READ AND SAVE THESE INSTRUCTIONS

Child Safety

When children become old enough to use the appliance, it is the legal responsibility of the parents or legal guardians to ensure that they are instructed in safe practices by qualified persons.

Do not allow anyone to climb, stand, lean, sit, or hang on any part of an appliance, especially a door, warming drawer, or storage drawer. This can damage the appliance, and the unit may tip over, potentially causing severe injury.

Do not allow children to use this appliance unless closely supervised by an adult. Children and pets should not be left alone or unattended in the area where the appliance is in use. They should never be allowed to play in its vicinity, whether or not the appliance is in use.

CAUTION

Items of interest to children should not be stored in an appliance, in cabinets above an appliance or on the backsplash. Children climbing on an appliance to reach items could be seriously injured.

Cleaning Safety

IMPORTANT SAFETY NOTICE: The California Safe Drinking Water and Toxic Enforcement Act requires the Governor of California to publish a list of substances known to the state to cause cancer, birth defects or other reproductive harm, and requires businesses to warn customers of potential exposure to such substances. The burning of gas cooking fuel and the elimination of soil during self-cleaning can generate some by-products which are on the list. To minimize exposure to these substances, always operate this unit according to the instructions contained in this booklet and provide good ventilation.

When self-cleaning, confirm that the door locks and will not open. If the door does not lock, do not run Self-Clean. Contact service.

Wipe out excessive spillage before self-cleaning the oven.

Birds have very sensitive respiratory systems. Keep pet birds out of the kitchen or other rooms where kitchen fumes could reach them. During self-clean, fumes are released that may be harmful to birds. Other kitchen fumes such as overheating margarines and cooking oils may also be harmful.

Keep oven free from grease build up.

Cookware Safety

NOTICE: Do not place food directly on oven bottom.

Follow the manufacturer's directions when using cooking or roasting bags.

Do not clean parts or accessories in the self-clean oven.

WARNING

Risk of electric shock

Use of a wrong core temperature probe can damage the insulation. Use only the core temperature probe intended for this appliance.

State of California Proposition 65 Warnings

WARNING

This product contains chemicals known to the State of California to cause cancer, birth defects or other reproductive harm.

Causes of damage

NOTICES:

- Accessories, foil, baking paper or cookware on the bottom of the oven interior: do not place any accessories on the bottom of the oven interior. Do not line the bottom of the oven interior with any type of foil whatever or baking paper. Do not place cookware on the bottom of the oven interior when a temperature above 122°F (50 °C) is set. This produces a build-up of heat. Baking and roasting times are no longer correct and the enamel is damaged.
- Water in the hot oven interior: Never pour water into the hot oven interior. Steam is produced. Damage to the enamel can arise due to the temperature change.
- Do not leave moist groceries in a closed oven for an extended period of time. It can lead to corrosion inside the oven.
- Fruit juice can leave stains in the oven. Always remove fruit juice immediately and wipe up first with a damp and then a dry cloth.
- Cooling with the appliance door open: only allow the oven cavity to cool when it is closed. Even if the appliance door is only open a little, front panels of adjacent units could be damaged over time.
- Highly soiled door seal: the appliance door will no longer close properly during operation if the door seal is highly soiled. Adjoining furniture fronts may be damaged. Always keep the door seal clean.
- Appliance door as a seat or storage surface: do not stand, sit or hang on the appliance door. Do not place any cookware or accessories on the appliance door.
- Inserting accessories: depending on the appliance type, accessories can scratch the door pane when closing the appliance door. Always slide accessories fully into the oven interior.
- Do not hold or carry the appliance by the door handle. The door handle cannot carry the weight of the device and could break off.

Protecting the environment

Unpack the appliance and dispose of the packaging in line with environmental requirements.

Tips for saving energy

- Open the appliance door as little as possible while cooking, baking or roasting.
- Use dark, black-painted or enameled baking forms. These absorb the heat particularly well.
- It is best to bake several cakes in succession. The oven is still warm. This shortens the baking time for the second cake. You can also slide in two loaf tins next to each other.
- In the hot air mode, you can bake simultaneously on several levels.
- For longer cooking times, you can switch off the oven 10 minutes before the end of the cooking time and you can use the residual heat to finish cooking.

Getting to know the appliance

You will get to know your new appliance here. We explain the control panel and the individual controls to you. You are informed about the oven interior and accessories.

Oven

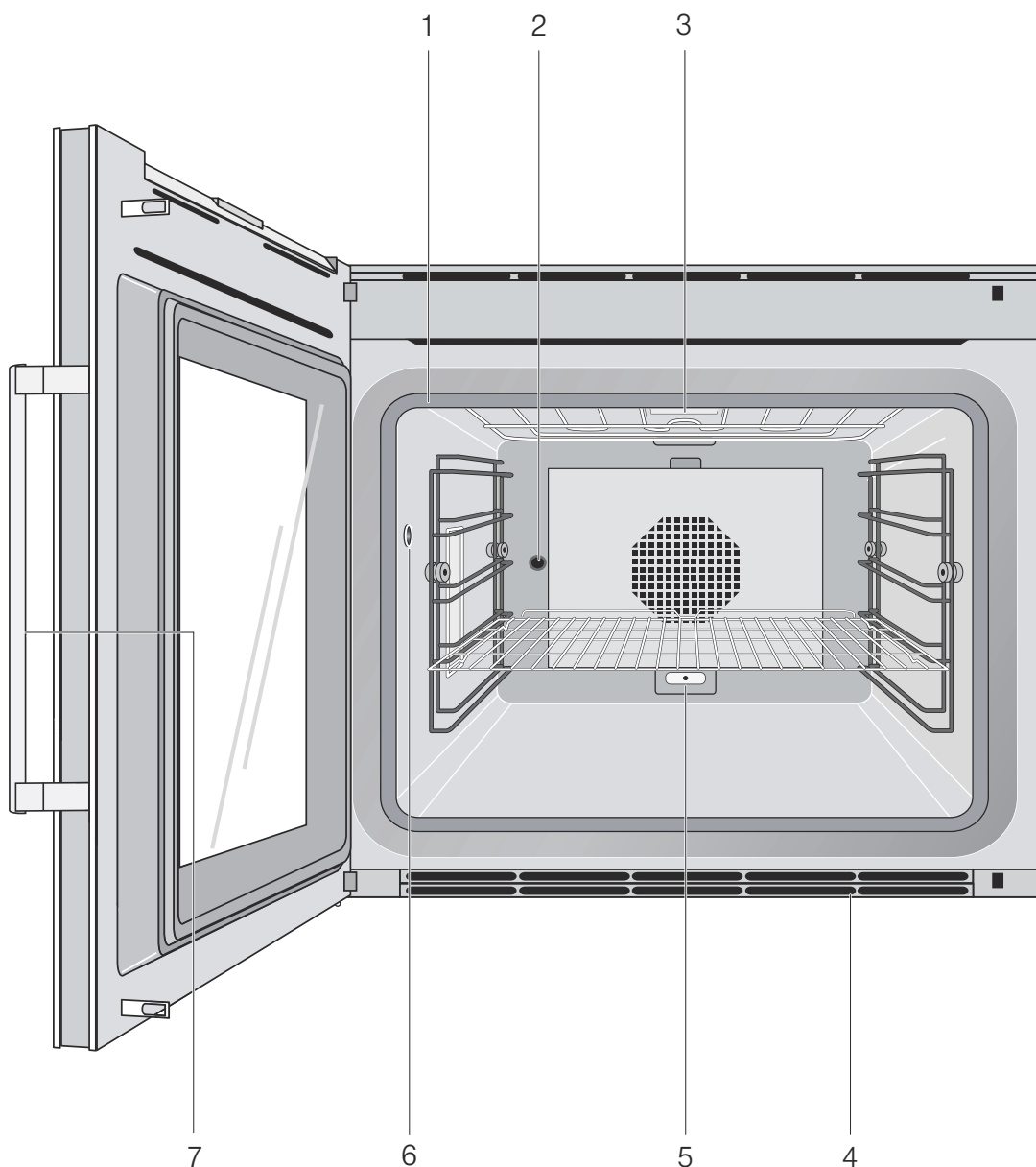

1	Door seal
2	Rotisserie spit drive
3	Grill heating element
4	Oven vents
5	Socket for additional heating element (special accessory for baking stone and roaster)

6	Socket for core temperature probe
7	Recessed handle

NOTICE: Do not place food directly on oven bottom.

Do not obstruct oven vents.

Displays and controls

These instructions apply to different versions of the appliance. Slight deviations are possible depending on the appliance type.

Operation is identical for all appliance versions.

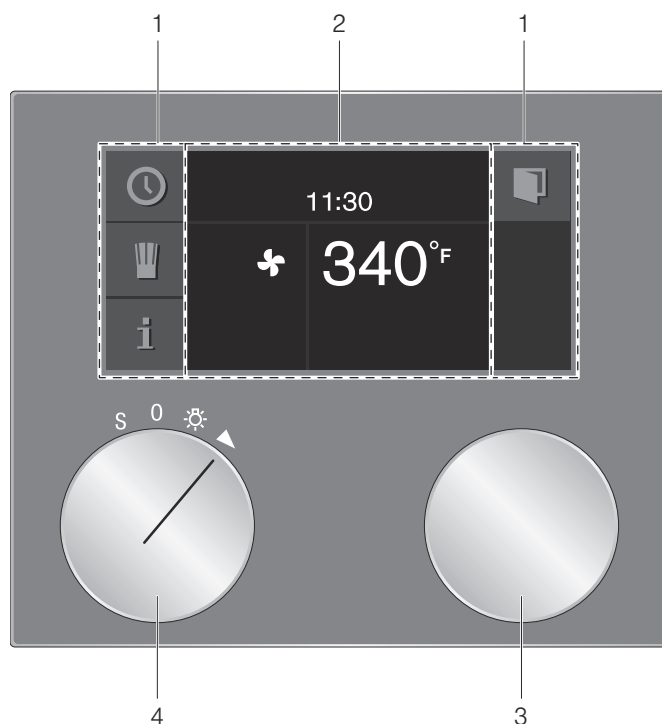

1	Control panel	These areas are touch-sensitive. Touch a symbol to select the applicable function.
2	Display	The display shows current settings and options, for example.
3	Rotary selector	With the rotary selector you can select the temperature and make other settings.
4	Program selector	With the program selector, you can select the heating function, the cleaning function or the basic settings.

Symbols

Symbol	Function
▶	Start
■	Stop
	Pause/end
X	Cancel
C	Delete
✓	Confirm/save settings
>	Selection arrow
🚪	Open appliance door
i	Launching additional information
⤴	Preheating with status display
🍷	Launching personal recipes
rec	Recording a menu
🔧	Edit settings
>A [^]	Enter a name
✕	Delete letters
🔒	Child lock
🕒	Launching the timer menu
🕒	Launching the Sabbath mode
🔧	Demo mode
🔧	Core temperature probe
🔧	Start rotisserie spit
🔧	Stop rotisserie spit
»	Start pre-roast stage
»	End pre-roast stage

Colors and display

Colors

The various colors serve to guide you in the various adjustment situations.

Orange	First settings Main functions
Blue	Basic settings Cleaning
White	Adjustable values

Presentation

The presentation of symbols, values or the entire display changes depending on the situation.

Zoom	The display of the setting you are just changing is enlarged. Just before it elapses, a duration that is just elapsing is enlarged (e.g. the last 60 seconds in the case of timers).
Minimized display screen	After a short time, the display screen is minimized and only the most important things are displayed. This function is the default and can be modified in the basic settings.

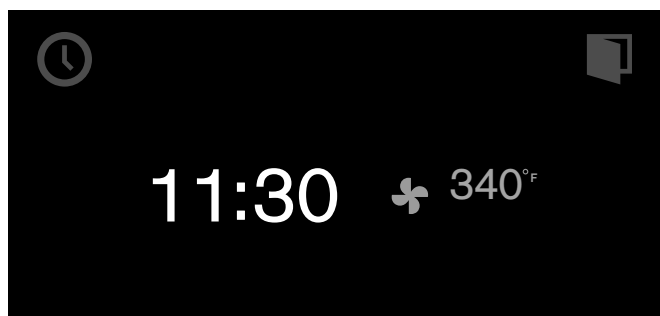

Automatic door opening

When you touch the  symbol, the appliance door springs open and you can open it fully with the handle recess at the side.

Automatic door opening does not work when the child lock is activated or in the event of a power failure. You can open the door manually with the handle recess at the side.

Additional information **i** and **i**[!]

By touching the **i** symbol, you can call up additional information. For example, information on the heating function set or on the current temperature of the cooking compartment.

Note: During continuous operation, small fluctuations in temperature are normal after the oven has heated up.

The **i**[!] symbol is displayed for important information and action prompts. Important information on safety and operation mode are occasionally shown automatically. These messages either disappear automatically after a few seconds or must be confirmed with .

Cooling fan

Your appliance has a cooling fan. The cooling fan switches on during operation. Depending on the appliance version, the warm air escapes above or under the door.

After removing cooked food, keep the door closed until the appliance cools down. The appliance door must not be left ajar, as adjoining kitchen furniture may be damaged. The cooling fan continues to run for a while and then switches off automatically.

CAUTION





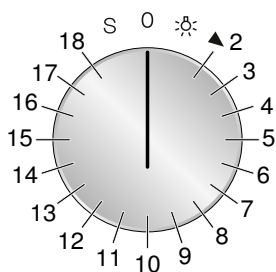



Do not cover up the ventilation slots. Otherwise, the appliance will become overheated.

Program selection positions



Position	Function/type of heating	Temperature	Application
0	Off position		
☀	Light		
2	Hot air	120 - 550°F (50 - 300°C) Default temperature 340°F (170°C)	Hot air: For cakes, cookies and baked casseroles on several levels. The fan in the back wall of the oven distributes the heat evenly throughout the cooking compartment.
3	Hot Air Eco*	120 - 550°F (50 - 300°C) Default temperature 340°F (170°C)	Energy-saving hot air mode for cakes, small baked items, baked casseroles, and gratins. The oven lighting remains off.
4	--- Bottom heating + top heating	120 - 550°F (50 - 300°C) Default temperature 340°F (170°C)	For cakes in pans or sheet cakes, baked casseroles, roasting.
5	--- Bottom heating + 1/3 top heating	120 - 550°F (50 - 300°C) Default temperature 340°F (170°C)	For sheet cakes, cookies, cakes with meringue, grilling, and baked casseroles with gratin. Very well-suited for a situation when the food should be heated from above toward the end of preparation.
6	--- Top heating	120 - 550°F (50 - 300°C) Default temperature 340°F (170°C)	Targeted heat from above, for example grilling cake topped with fruit and meringue.
7	--- 1/3 Top heating + bottom heating	120 - 550°F (50 - 300°C) Default temperature 340°F (170°C)	For cheesecake, bread in loaf pans, dishes in a water bath (e.g. egg custard, crème brûlée). For roasting without a lid and warming up foods (foods dry out less). Very well-suited for a situation when the food should be heated from above toward the end of preparation.
8	--- Bottom heat	120 - 550°F (50 - 300°C) Default temperature 340°F (170°C)	For the final baking stage (such as for moist cakes topped with fruit), for preserving, for dishes in a water bath.
9	Hot air + bottom heat	120 - 550°F (50 - 300°C) Default temperature 340°F (170°C)	Additional heat from below for moist cakes, such as cake topped with fruit.
10	Hot air + 1/3 bottom heat	120 - 550°F (50 - 300°C) Default temperature 340°F (170°C)	For high baked casseroles, lasagne, onion tart, egg dishes (e.g. tortillas, farmers' omelettes).
11	Full surface grill + circulated air	120 - 550°F (50 - 300°C) Default temperature 430°F (220°C)	Even, all-round heating for meat, poultry and whole fish.
12	Flat grill	120 - 550°F (50 - 300°C) Default temperature 430°F (220°C)	To grill flat pieces of meat, sausages or fillets of fish. Cooking "au gratin."

* Type of heating to determine the energy efficiency class in accordance with EN 50304.

Position	Function/type of heating	Temperature	Application
13	 Compact grill	120 - 550°F (50 - 300°C) Default temperature 430°F (220°C)	Only the center part of the grill heating element is heated. Energy-saving grilling for small amounts.
14	 Baking stone function	120 - 550°F (50 - 300°C) Default temperature 480°F (250°C)	Baking stone only available as a special accessory Baking stone heated from below for crisp stone-baked pizza, bread or rolls.
15	 Roaster function	120 - 430°F (50 - 220°C) Default temperature 360°F (180°C)	Roasting dish only available as a special accessory Heatable cast iron roasting pan for large quantities of meat, baked casseroles or holiday roasts.
16	 Dough proofing	85 - 120°F (30 - 50°C) Default temperature 100°F (38°C)	Proofing: For yeast dough and sourdough. Dough will proof considerably more quickly than at room temperature. The optimal temperature setting for yeast dough is 100°F (38 °C).
17	 Defrosting	100 - 140°F (40 - 60°C) Default temperature 115°F (45°C)	Even, gentle defrosting. For vegetables, meat, fish and fruit.
18	 Keep warm	85 - 250°F (30 - 120°C) Default temperature 160°F (70°C)	Keeping food warm, pre-heating crockery.
S	 Basic settings		The basic settings of your appliance can be adjusted individually.
	 + Pyrolytic cleaning	905°F (485°C)	Self-cleaning

* Type of heating to determine the energy efficiency class in accordance with EN 50304.

Accessories

Use only the accessories included or obtainable from after-sales service. It has been specially adapted to your appliance. Make sure you always insert accessories into the interior the right way round.

Your appliance comes with the following accessories:

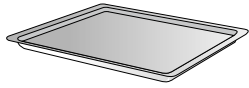

Baking tray, enameled



Wire grill tray



Grill tray with wire rack

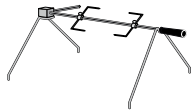

Rotisserie spit

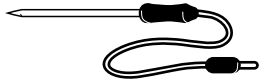

Plug-in core temperature probe

Special accessories

You can order the following accessories from your specialist dealer:

BA 478 110 Handle, stainless steel

BA 018 103 Pull-out system

Fully extendable telescopic pull-out rack and pyrolysis-proof cast frame

BA 028 113 Baking tray, enameled, 30 mm deep

BA 038 103 Wire rack, chrome-plated, with feet

BA 058 113 Heating element for baking stone and roaster

BA 058 133 Baking stone

Including heating element and pizza paddle (order heating element separately)

BS 020 002 Pizza paddle, set of 2

GN 340 230 Cast aluminum roaster GN 2/3, 165 mm high, non-stick

Use the accessories only as indicated. The manufacturer assumes no liability for incorrect usage of the accessories.

Before first use

Here you find out what you have to do before preparing meals with your appliance for the first time. Read the section entitled **Important safety notes** beforehand.

The appliance must be completely fitted and connected.

The "First settings" menu appears in the display after the mains has been connected. You can now set your new appliance:

- Language
- Time format
- Time
- Date format
- Date
- Temperature format

Notes

- The "First settings" menu only appears the first time the appliance is switched on after connection to the mains or if the appliance had no power supply for several days. After connection to the power, the GAGGENAU logo first appears for about 30 seconds, after which the "First settings" menu appears automatically.
- You can change the settings at any time (see the section entitled **Factory setting**).

Setting the language

The default language appears in the display.

- 1 Select the desired display language with the rotary selector.
- 2 Confirm with ✓.

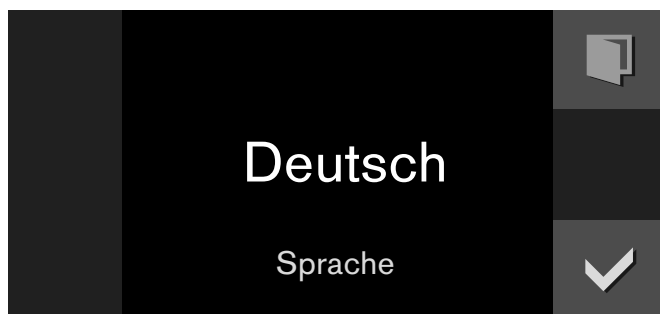

Note: When the language is changed, the system is restarted; this procedure takes a few seconds.

Setting the time format

the two possible formats 24h and AM/PM appear in the display. The default format is 24h.

- 1 Set the required format with the rotary selector.
- 2 Confirm with ✓.

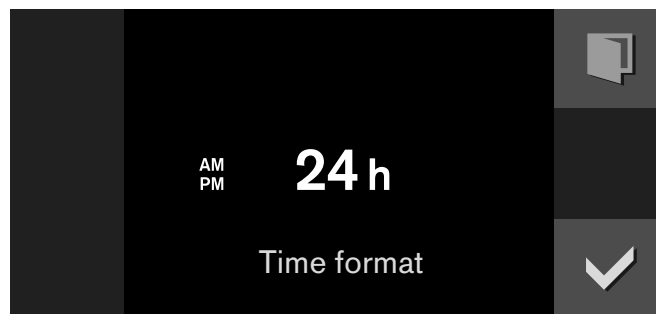

Setting the time

The time appears in the display.

- 1 Set the required time with the rotary selector.
- 2 Confirm with ✓.

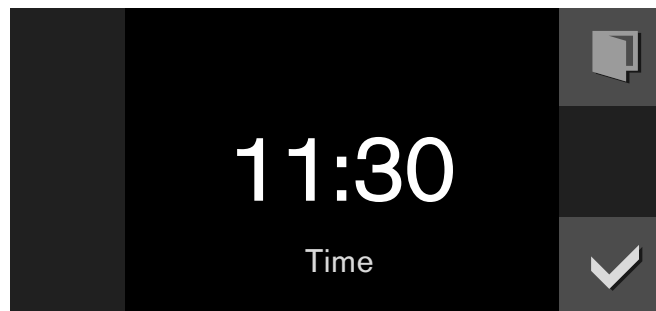

Setting the date format

The three possible formats D.M.Y, D/M/Y and M/D/Y appear in the display. The D.M.Y is the default.

- 1 Set the required format with the rotary selector.
- 2 Confirm with ✓.

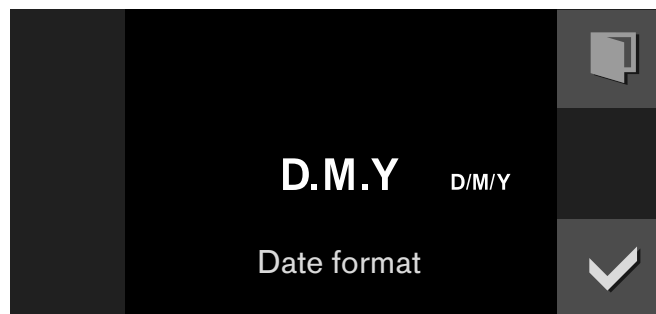

Setting the date

The default date appears in the display. The day setting is already active.

- 1 Set the required day with the rotary selector.
- 2 Switch to the month setting with the > symbol.
- 3 Set the month with the rotary selector.
- 4 Switch to the year setting with the > symbol.
- 5 Set the year with the rotary selector.
- 6 Confirm with ✓.

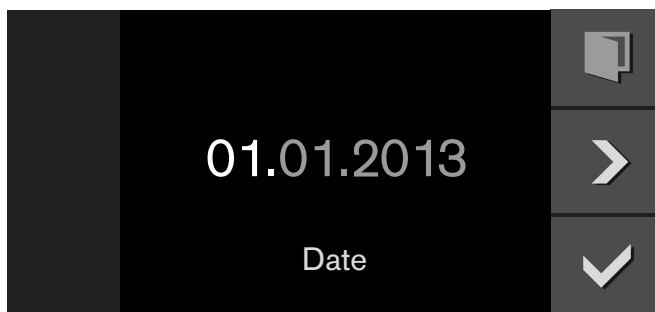

Setting the temperature format

The two possible formats °C and °F appear in the display. The °C format is selected by default.

- 1 Set the required format with the rotary selector.
- 2 Confirm with ✓.

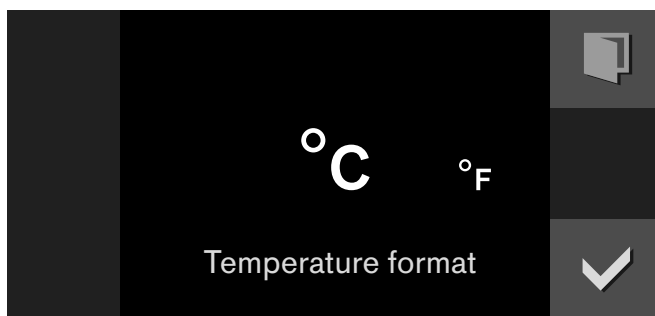

Completing initial set-up

"Initial set-up complete" appears in the display.

Confirm with ✓.

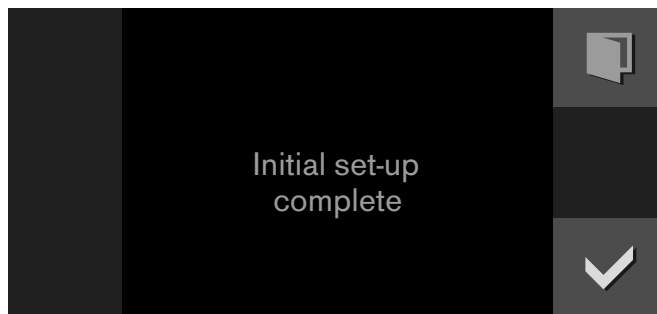

The appliance enters the standby mode and the standby display appears. The appliance is now ready for operation.

Heating up the oven

Make sure there are no packaging remainders left in the interior.

Heat up the empty, closed oven to dispel the 'new' smell. An hour with convection  at 390° F (200°C) is ideal. For details of how to set this heating function, refer to the section entitled **Operating the appliance**.

Cleaning accessories

Before using accessories for the first time, thoroughly clean them with hot soapy water and a soft dish cloth.

Activating the appliance

Standby

The appliance is in the standby mode when no function is set or the child lock is activated.

The control panel's brightness is reduced in the standby mode.

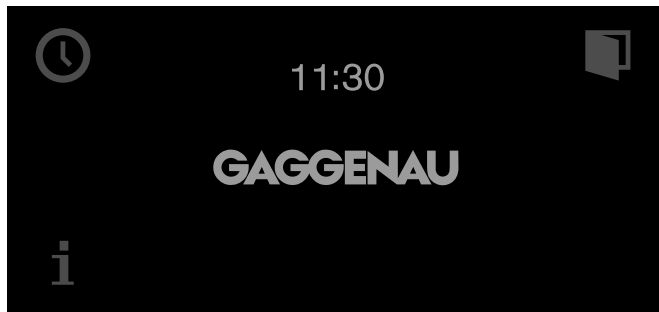

Notes

- There are various displays for the standby mode. The GAGGENAU logo and the time are set by default. Refer to the section entitled **Factory setting** if you would like to change the display.
- The display's brightness depends on the vertical viewing angle. You can adjust the display by way of the "Brightness" setting in the factory settings.

Activate appliance

In order to exit standby mode, you can either

- Set the function selector,
- Touch a control panel,
- or open or close the door.

Now you can set the desired function. Read the appropriate chapters to learn how to set functions.

Notes

- If "Standby display = off" is selected in the factory setting, you must turn the function selector to exit the standby mode.
- The standby display appears again if you have not made any settings for a long while after activation.
- The cooking compartment lighting goes out after a little while if the door is open.

Operating the appliance

Oven interior

The cooking compartment has five shelf levels.

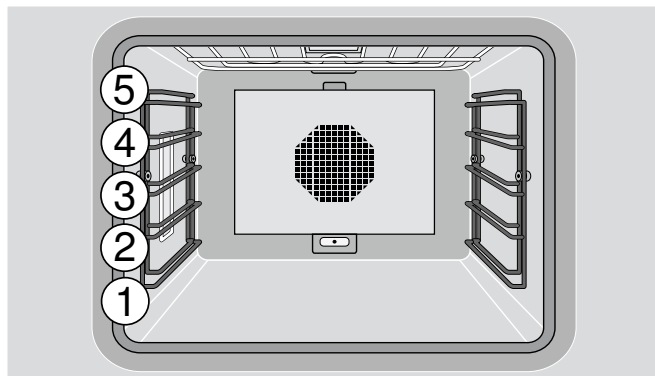

⚠ CAUTION

Do not place anything on the cooking compartment floor. Do not cover it with aluminium foil. A build-up of heat could damage the appliance or cause injury.

⚠ CAUTION

Do not slide any accessories between the shelf positions, or they may tip.

Inserting accessories

The accessories feature a latching function. The latching function prevents tilting of accessories when pulling them out. You must insert accessories in the oven interior correctly so that tilt protection will work.

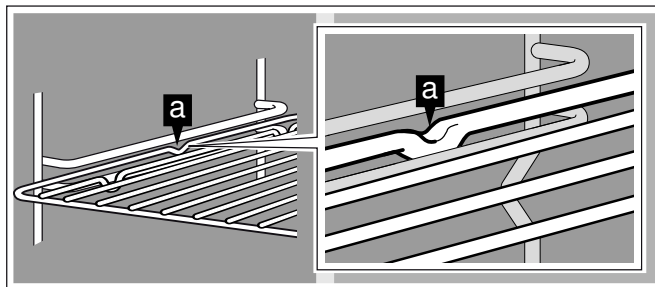

When inserting the rack, make sure

- that the engaging lug (a) points downward
- that the rack's safety clip is at the rear and top.



Turning on

- 1 Set the required heating mode using the function selector. The chosen heating mode and the default temperature are displayed.
- 2 If you want to change the default temperature: set the required temperature with the rotary selector.

The preheating symbol  appears on the display. The bar continuously shows the preheating status. When the set temperature is reached, a signal sounds and the preheating symbol  goes off.

Note: The oven interior lighting stays switched off at a temperature setting below 160° F (70°C).

Switching off:

Turn the function selector to 0.

Quick heat

Your appliance reaches the required temperature particularly fast with the "Quick heat" function.

So you achieve a uniform cooking result, do not place your meal in the oven interior until "Quick heat" has ended.

You must activate the "Quick heat" function in the factory setting (see section entitled **Factory setting**).

Safety lock

For your protection, the appliance has a safety shut-off feature. Every heating operation is switched off after 12 hours if the appliance is not operated during this time. A message appears in the display.





Exception:

programming with the long-term timer.

Turn the program selection to 0, after which you can operate the appliance in the manner to which you are accustomed.

Timer functions

In the timer menu, set:

-  Timer
-  Stopwatch
-  Cooking time (not in the idle state)
-  Cooking time end (not in the idle state)

Launching the timer menu

You can launch the timer menu from any mode. Only from the factory settings, program selection is set to S, the time menu is not available.

Touch the  symbol.

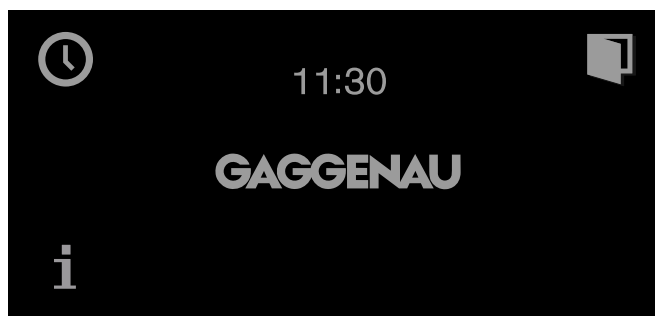

The timer menu appears.

Timer

The timer runs independently of the other appliance functions. You can enter a maximum of 90 minutes.

Setting the timer

- 1 Call up the Timer menu. The "Timer" function  is displayed.
- 2 Turn the rotary selector to set the desired time.

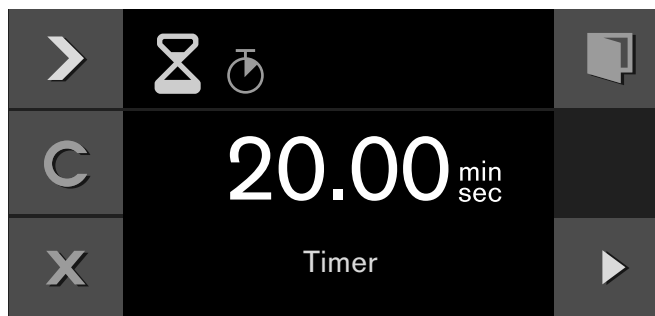

- 3 Start with .

The Timer menu closes and the timer starts to run. The symbol for the timer ⌚ appears on the display and the time can be seen counting down.

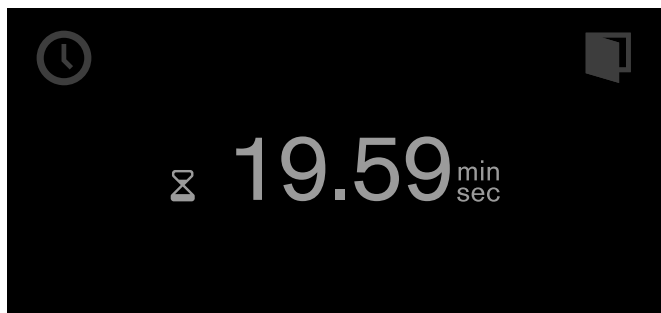

A signal sounds once the time has elapsed. The audible signal ceases if you touch the ✓ symbol.

You can exit the Timer menu at any time by touching the ✕ symbol. This way, the settings are lost.

Suspend timer:

Call up the Timer menu. Select the "Timer" function with ➤, select ⌚, and touch the || symbol. To let the timer run on, touch the ▶ symbol.

Switch off the timer early:

Call up the Timer menu. Select the "Timer" function with ➤, select ⌚, and touch the C symbol.

Stopwatch

The stopwatch runs independently of the other appliance functions.

The stopwatch counts up from 0 seconds to 90 minutes.

It has a pause function. Therefore, you can stop the timer in between times.

Starting the stopwatch

- 1 Launch the timer menu.
- 2 With ➤, select the "Stopwatch" function ⌚.

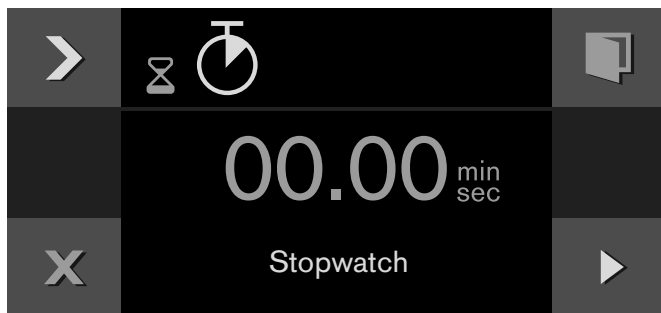

- 3 Start with ▶.

The timer menu is closed and the time runs. The ⌚ symbol and the elapsing timer are shown in the display.

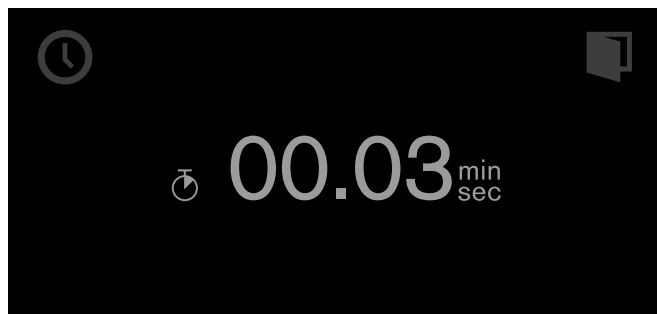

Stopping and restarting the stopwatch

- 1 Launch the timer menu.
- 2 With ➤, select the "Stopwatch" function ⌚.
- 3 Touch the || symbol.

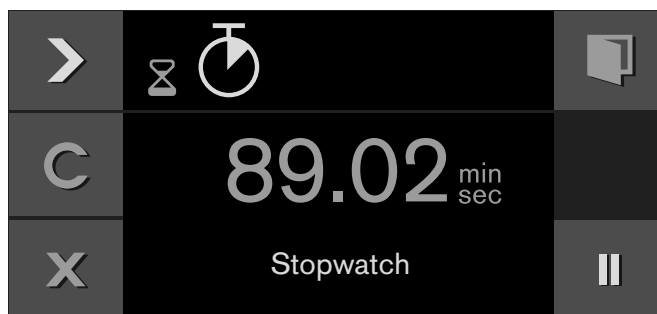

The time stops. The symbol changes to Start ▶ again.

- 4 Start with ▶.

The time continues to run. Once 90 minutes have been reached, the display pulsates and a signal sounds. It goes off when you touch the ✓ symbol. The ⌚ symbol disappears from the display. The operation has ended.

Switching off the stopwatch:

Launch the timer menu. With ➤, select the "Stopwatch" function ⌚ and touch the C symbol.

Cooking time

If you set a cooking time for your meal, the appliance switches off heating automatically after this time has elapsed.

You can set a cooking time from 1 minute to 23:59 hours.

Setting the cooking time

You have set the heating function and temperature and you have placed your dish in the oven interior.

- 1 Touch the ⌚ symbol.
- 2 With ➤, select the "Cooking time" function ⌚.
- 3 Set the required cooking time with the rotary selector.



- 4 Start with ▶.

The appliance starts. The timer menu is closed. The temperature, the operating mode, the remaining cooking time and the end of the cooking time appear in the display.

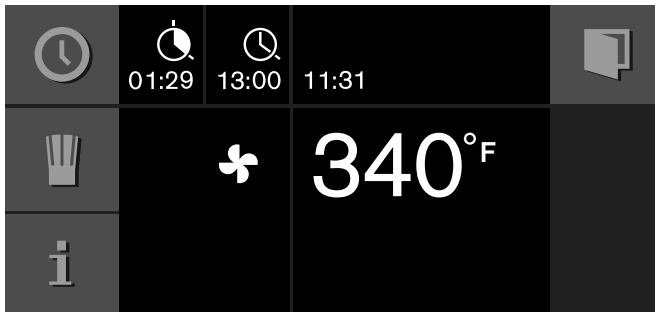

One minute before expiration of the cooking time, the expiring cooking time is enlarged in the display.

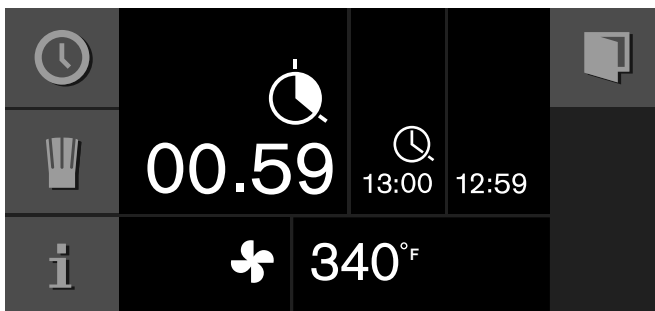

The appliance switches off after expiration of the cooking time. The ⌚ pulsates and a signal sounds. It goes off prematurely if you touch the ✓ symbol, open the appliance door or set the program selection to 0.

Interrupting the cooking time:

Launch the timer menu. With ➤, select the "Cooking time" function ⌚. With || interrupt the cooking time. With ▶ continue the cooking time.

Changing the cooking time:

Launch the timer menu. With ➤, select the "Cooking time" function ⌚. Set the cooking time with the rotary selector. Start with ▶.

Clearing the cooking time:

Launch the timer menu. With ➤, select the "Cooking time" function ⌚. Clear the cooking time with C. Return to normal operation with X.

Canceling the entire operation:

Set the program selection to 0.

Note: You can also change the heating function and temperature during the cooking time.

End of cooking time

You can defer the end of the cooking time until later.

Example: it is 2 pm. The meal takes 40 minutes to cook. It should be ready by 3.30 pm.

Enter the cooking time and shift the end of the cooking time to 3.30 pm. The electronic circuitry calculates the starting time. The appliance starts automatically at 2:50 pm and switches off at 3.30 pm.

Note that easily perishable foodstuffs must not be left in the oven for too long.

Shifting the end of the cooking time

You have set the heating function, the temperature and the cooking time.

- 1 Touch the ⌚ symbol.
- 2 With ➤, select the "End of cooking time" function ⌚.



- 3 Set the required cooking time end with the rotary selector.
- 4 Start with ▶.

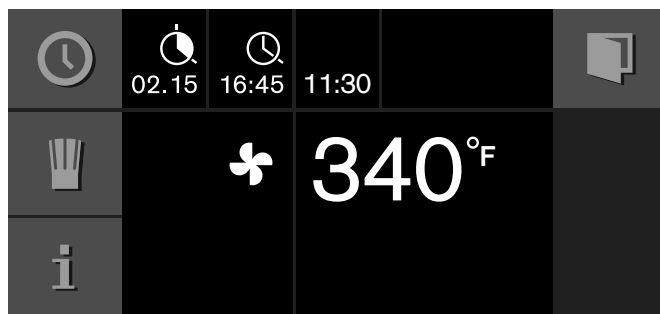

The appliance assumes a waiting mode. The operating mode, the temperature, the cooking time and the end of the cooking time appear in the display. The appliance starts at the calculated time and switches off automatically when the cooking time has elapsed.

Note: If the ⌚ symbol flashes: you have not set a cooking time. Always set a cooking time first.

The appliance switches off after expiration of the cooking time. The ⌚ pulsates and a signal sounds. It goes off prematurely if you touch the ✓ symbol, open the appliance door or set the program selection to 0.

Changing the cooking time end:

Launch the timer menu. With ➤, select "End of cooking time" ⌚. Set the required cooking time end with the rotary selector. Start with ▶.

Canceling the entire operation:

Set the program selection to 0.

Sabbath mode and Yom Tov mode

Sabbath mode

With this function, the appliance maintains a temperature between 120 and 450°F (50 and 230°C) with the convection heating function.

You can keep dishes warm for up to 74 hours without having to switch on or off.

Note that easily perishable foodstuffs must not be left in the oven for too long.

Note: You must activate the Sabbath mode in the factory setting in order to operate the mode.

Follow these steps:

- 1 Set the program selector to S.
- 2 Select "Factory setting" with the rotary selector.
- 3 Confirm by touching the ✓ symbol.
- 4 Rotate the selector to Sabbath mode ⌚.
- 5 Confirm by touching the ✓ symbol.
- 6 Rotate the selector to "activate".
- 7 Confirm by touching the ✓ symbol.
- 8 Turn the oven off.

Setting the Sabbath mode

- 1 Set the program selector to ⌚.
- 2 Touch the ⌚ symbol.
The suggested value of 24h at 185° F (85° C) appears in the display. Start with ▶
- or -
Change the cooking time and the temperature.

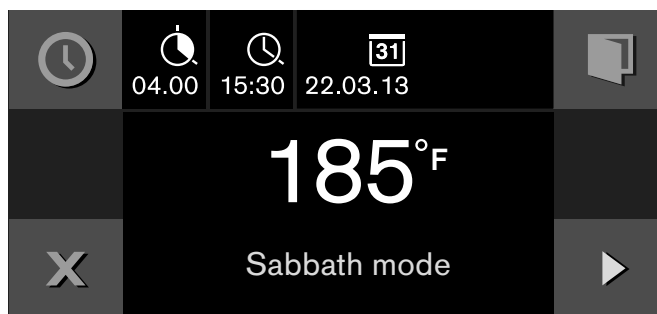

- 3 Changing the cooking time ⌚ :
Touch the ⌚ symbol. Set the preferred cooking time with the rotary selector. You can set up to 74 hours. Confirm by touching the ✓ symbol. Then changing the temperature becomes an option.
- 4 Changing the temperature:
Set the required temperature with the rotary selector.

5 Start with ▶.

The appliance starts.  and the temperature appear in the display. The Sabbath screen will appear as shown.



The oven and display lighting is off. The control panel is blocked and no tone can be heard when you touch it.

The appliance no longer heats after expiry of the time. The display is blank. Set the program selector to 0.

Switching off:

To cancel the operation, set the program selector to 0.

Yom Tov mode

With this function, the appliance is programmed to perform in three stages.

Stage 1 and 2 can be programmed for a maximum total duration of 74 hours. The duration of Step 3 is 1 hour and cannot be modified.



Stage 1: maintains a warm temperature of 122° F (50° C) in the convection heating function. The interior oven lights remain off through this stage.

Stage 2: the appliance raises to a desired temperature setting and maintains a temperature between 120 and 450° F (50 -230° C). For warming and cooking foods in the convection heating function. The desired time can be adjusted for this stage. The interior oven lights will be on during this time.

Stage 3: maintains a warm temperature of 122° F (50° C) in the convection heating function for 1 hour after stage 2 has ended. The interior oven lights will be on during this time.

Note that easily perishable foodstuffs must not be left in the oven for too long.







Setting the Yom Tov mode

- 1 Set the program selector to .
- 2 Touch the .

The suggested value of 24h at 185° F (85° C) appears in the display.



To set Stage 2 cooking time with rotary selector:

- 1 Touch the  symbol to adjust the duration of Stage 2 cooking time .
- 2 Set the desired Stage 2 cooking time with the rotary selector.
- 3 Touch the  symbol to adjust the end of Stage 2 cooking time .
- 4 Select the end time with the rotary selector.
- 5 Change the date if needed by touching the  symbol to .
- 6 Rotate the selector to the desired date.
- 7 Confirm settings by touching the  symbol.

To set Stage 2 temperature:

- 1 Rotate selector to desired Stage 2 temperature.
- 2 Start with ▶.

The temperatures of Stage 1 and Stage 2 appear in the display. The remaining time to the beginning of Stage 2 is counted down in the display. The Yom Tov screen will appear as shown.

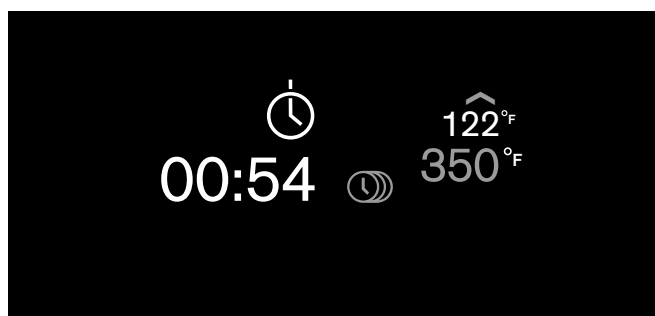

The program will begin with the pre-set warm temperature without light, then advance to the programmed temperature with light until the end of the set date and time, and then maintain the pre-set warm temperature for 60 minutes.

The appliance no longer heats after expiry of the time. The display is blank. Set the program selector to 0.

Switching off:



To cancel the operation, set the program selector to 0.

Personal recipes

You can save up to 50 individual recipes. You can record a recipe. You can assign these recipes a name so that you can fall back on them quickly and conveniently if you need them.

Recording a recipe

You can set up to five phases in succession and you can record them.

- 1 Set the program selection to the required heating function.
The  symbol is displayed.
- 2 Touch the  symbol.
- 3 Choose a free storage location with the rotary selector.
- 4 Touch the  symbol.

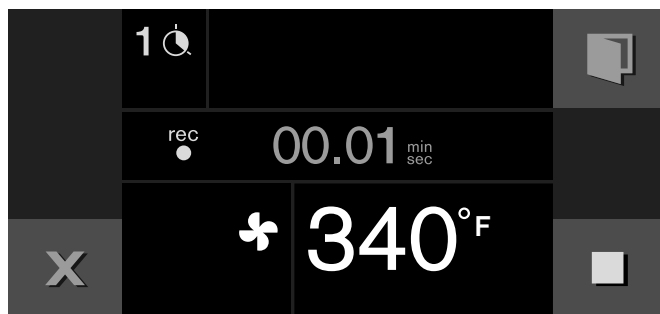



- 5 Set the desired temperature with the rotary selector.
- 6 The cooking time is recorded.
- 7 Recording another phase:
Set the program selection to the required heating function. Set the required temperature with the rotary selector. A new phase begins.
- 8 Once the appliance has achieved the desired cooking result, touch the  symbol to end the recipe.
- 9 Enter the name under "ABC" (see Section entitled *Entering names*).

Notes

- Recording a phase does not begin until the appliance has reached the set temperature.
- Every phase must last at least one minute.
- During the first minute you can change the heating function or the temperature.





Enter the core temperature for a phase:

Insert the core temperature probe in the socket in the oven interior. Set the heating function and





temperature. Touch the  symbol. With the rotary selector, enter the required temperature and confirm it with .

Programming a recipe

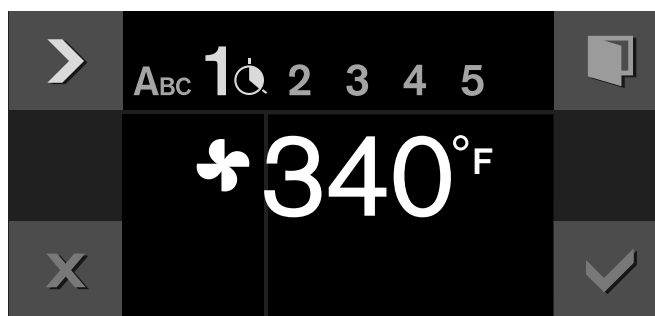

You have the option of programming and saving up to five phases of preparation.

- 1 Set the program selection to the required heating function. Set the required temperature with the rotary selector.
The  symbol is displayed.
- 2 Touch the  symbol.
- 3 Choose a free storage location with the rotary selector..
- 4 Touch the  symbol.
- 5 Enter the name under "ABC" (see Section entitled *Entering names*).
- 6 Choose the first phase with the  symbol.
The heating function and temperature set at the start are displayed. You can change the heating function and temperature with the rotary selectors.



- 7 Choose the time setting with the  symbol.
- 8 Set the required cooking time with the rotary selector.
- 9 Choose the next phase with the  symbol.
- or -
Preparation is complete, end input.
- 10 Save with .
- or -
Cancel with  and quit the menu.

Enter the core temperature for a phase:

Choose the next phase with the  symbol. Set the heating function and temperature. Touch the  symbol. With the rotary selector, enter the required temperature and confirm it with .

Note: For phases for which a core temperature has been programmed you cannot set a cook time.

Entering a name

- 1 Enter the recipe's name under "ABC".

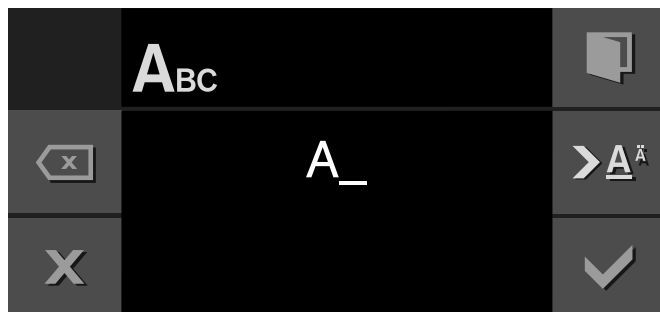

Rotary selector	Selecting letters A new word always begins with an upper case letter.
>A ^Ä	Press briefly: cursor to the right Press long: switch to diacritics and special characters Press twice: insert line space
>Ä	Press briefly: cursor to the right Press long: switch to normal characters Press twice: insert line space
⊞	Clear letters

- 2 Save with ✓.
- or -
Cancel with X and quit the menu..

Note: For entering a name, Latin characters, certain special characters and numbers are available.

Starting a recipe

- 1 Set the program selection to any heating function. The symbol is displayed.
- 2 Touch the symbol. Set the required recipe with the rotary selector.
- 3 Start with ▶.
Operation begins. Its duration elapses visibly. The settings of the phases appear in the display bar.

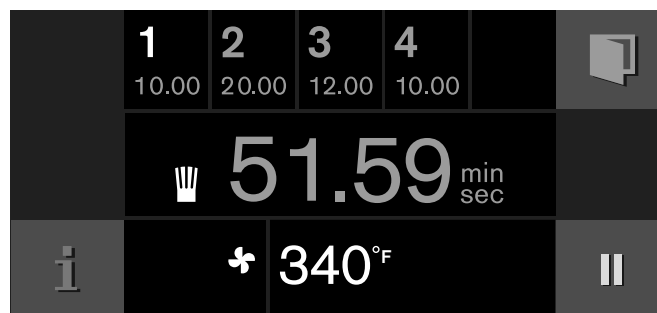

Notes

- The cooking time does not start counting down until the appliance has reached the set temperature.
- You can use the rotary selector to change the temperature while the recipe is in progress. This does not change the saved recipe.

Deleting a recipe

- 1 Set the function selector to any type of heating. The symbol is displayed.
- 2 Touch the symbol.
- 3 Use the rotary selector to select the desired recipe.
- 4 Delete the recipe with C.
- 5 Confirm with ✓.

Core temperature probe

The core temperature probe enables exact cooking to the spot. It measures the temperature inside the food being cooked. Automatic switching off when the desired core temperature is reached ensures that each cooked food is cooked precisely.

Use the included core temperature probe only. You can purchase one as a spare part from after-sales service or in the online shop.

The core temperature probe is damaged at temperatures above 480°F (250°C). Therefore, only ever use it in your appliance at a maximum temperature setting of 445°F (230°C).

Always remove the core temperature probe from the oven interior after use. Never store it in the oven interior.

After every use, clean the core temperature probe with a moist cloth. Do not wash it in a dishwasher!

⚠ WARNING

Risk of electric shock

Use of a wrong core temperature probe can damage the insulation. Use only the core temperature probe intended for this appliance.

⚠ WARNING

Risk of burns

The oven interior and the core temperature probe become very hot. Use oven mitts to plug and unplug the core temperature probe.

Insert the core temperature probe in the food to be cooked

Insert the core temperature probe in the food to be cooked before you place it in the oven interior.

Insert the metal tip at the thickest point in the food you are cooking. Make sure that the end of the tip is approximately in the center. It must not be placed in the fat and must not touch any cookware or bones.



If there are several pieces, insert the core temperature probe in the middle of the thickest piece.

Insert the core temperature probe completely, if possible.

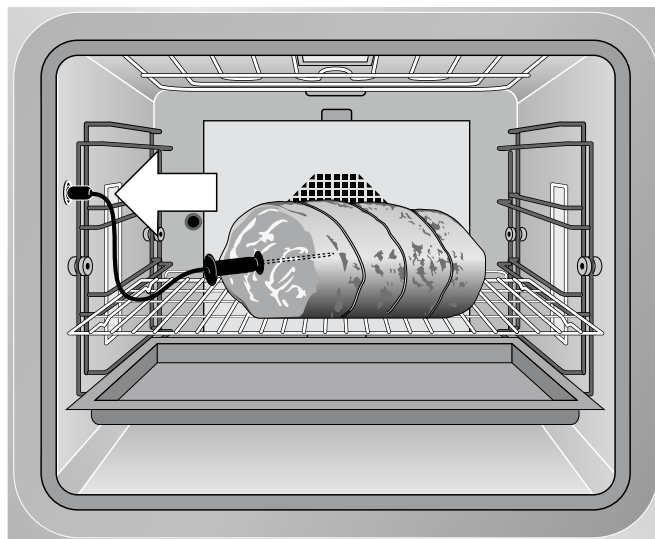
In the case of poultry, make sure that the tip of the core temperature probe is not in the cavity in the center, but in the meat between the belly and upper leg.



Setting the core temperature

- 1 Insert food into the oven interior with the core temperature probe inserted. Insert the core temperature probe in the socket in the oven interior and close the appliance door. Do not jam the core temperature probe's cable!  and the current core temperature appear in the display.
- 2 Set the program selection to the required heating function.
- 3 Set the oven interior temperature with the rotary selector.
- 4 Touch the  symbol. With the rotary selector, set the required core temperature and confirm it with .
The set core temperature must be higher than the current core temperature.

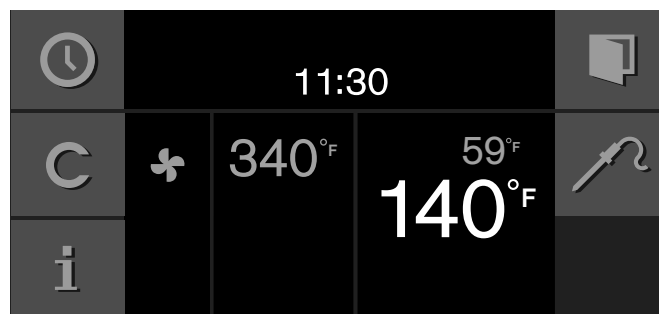



- 5 The appliance heats with the set heating function. The current core temperature is displayed and, under it, the set core temperature. You can change the set core temperature at any time.

A signal sounds when the set core temperature in the food has been reached. The cooking mode is ended automatically. Confirm with  and turn the program selection to 0.



Notes

- The measurable range is 59 to 210° F (15 to 99° C). Outside the measurable range, "--°F" is displayed for the current core temperature.
- If you leave the food in the cooking compartment for some time after cooking, the core temperature will continue to rise somewhat due to the residual heat in the cooking compartment.
- If at the same time you adjust a programming with the core temperature probe and the cooking time timer, then the programming switches the device off that reaches the specified value first.

Changing the core temperature set:

Touch the  symbol. Use the rotary selector to change the set core temperature for the food and confirm with .

Deleting the core temperature set:

Touch the  symbol. Delete the set core temperature with . The appliance continues heating in normal cooking mode.

Core temperature guidelines

Use chilled food only, not frozen food. The details given in the table are guidelines. Results depend on the quality and composition of the food.

For hygiene reasons, critical foodstuffs such as fish and game should reach a core temperature of 143 - 158° F (62 - 70 °C); for poultry and minced meat this should be as high as 176 - 185° F (80 - 85 °C).

Food	Core temperature guideline
Beef	
Sirloin, tenderloin, entrecôte	
very rare	113 - 117°F (45 - 47 °C)
rare	122 - 126°F (50 - 52 °C)
medium	137 - 140°F (58 - 60 °C)
well-done	158 - 167°F (70 - 75 °C)
Roast beef	176 - 185°F (80 - 85 °C)

Food	Core temperature guideline
Pork	
Pork roast	162 - 176°F (72 - 80 °C)
Pork loin	
medium	149 - 158°F (65 - 70 °C)
well-done	167°F (75 °C)
Meat loaf	185°F (85 °C)
Fillet of pork	149 - 158°F (65 - 70 °C)
Veal	
Veal roast, well-done	167 - 176°F (75 - 80 °C)
Breast of veal, stuffed	167 - 176°F (75 - 80 °C)
Saddle of veal	
medium	137 - 140°F (58 - 60 °C)
well-done	149 - 158°F (65 - 70 °C)
Fillet of veal	
rare	122 - 126°F (50 - 52 °C)
medium	137 - 140°F (58 - 60 °C)
well-done	158 - 167°F (70 - 75 °C)
Game	
Saddle of venison	140 - 157°F (60 - 70 °C)
Leg of venison	158 - 167°F (70 - 75 °C)
Venison loin steaks	149 - 158°F (65 - 70 °C)
Saddle of hare or rabbit	149 - 158°F (65 - 70 °C)
Poultry	
Chicken	185°F (85 °C)
Guinea fowl	167 - 176°F (75 - 80 °C)
Goose, turkey, duck	176 - 185°F (80 - 85 °C)
Duck breast	
medium	131 - 140°F (55 - 60 °C)
well-done	158 - 176°F (70 - 80 °C)
Ostrich steak	140 - 149°F (60 - 65 °C)

Food	Core temperature guideline
Lamb	
Leg of lamb	
medium	140 - 149°F (60 - 65 °C)
well-done	158 - 176°F (70 - 80 °C)
Saddle of lamb	
medium	131 - 140°F (55 - 60 °C)
well-done	149 - 167°F (65 - 75 °C)
Mutton	
Leg of mutton	
medium	158 - 167°F (70 - 75 °C)
well-done	176 - 185°F (80 - 85 °C)
Saddle of mutton	
medium	158 - 167°F (70 - 75 °C)
well-done	176 °F (80 °C)
Fish	
Fillet	144 - 149°F (62 - 65 °C)
Whole	149°F (65 °C)
Terrine	144 - 149°F (62 - 65 °C)
Other provisions	
Bread	194°F (90 °C)
Paté	162 - 167°F (72 - 75 °C)
Terrine	140 - 158°F (60 - 70 °C)
Foie gras	113°F (45 °C)

Rotisserie spit

Using the rotisserie spit, you can prepare large roasts such as rolled roast and poultry particularly well. The meat becomes crispy and brown all round.

You can use the rotisserie spit in all modes of operation. You achieve the best results with the "full surface grill" or "top heat" heating functions.

CAUTION

Do not use the temperature probe in combination with the rotisserie spit.

Preparation

- 1 Insert both supports in the sockets on the grill tray. The drive is on the left.
- 2 Plug the right retaining clip onto the rotisserie spit and screw it in firmly.
- 3 Place the food you want to cook on the rotisserie spit's center. Secure protruding parts (e.g. wings) to make sure they do not touch the grill heating element.

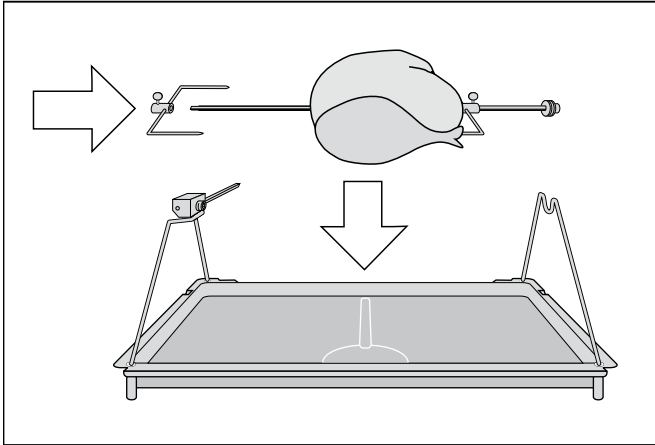

- 4 Plug the left retaining clip onto the rotisserie spit and screw it in firmly.
- 5 Place the rotisserie spit on the supports. Latch the square shaft into the drive section.

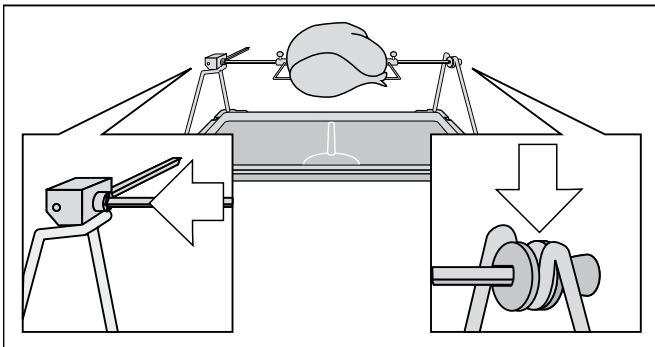

- 6 Insert the rotisserie spit in the lowest insertion level in the oven. The drive spindle must engage in the opening on the oven's rear wall.

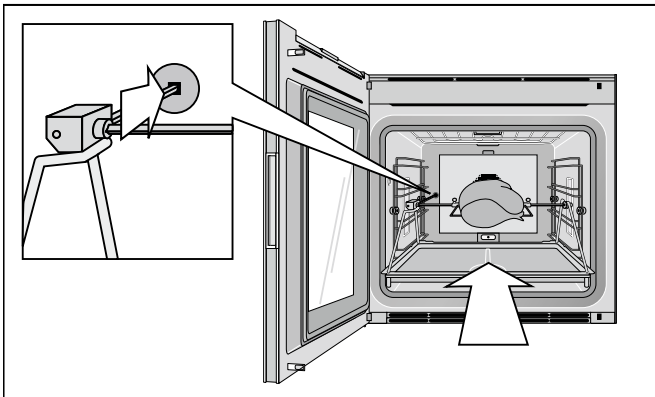

Switching on the rotisserie spit

- 1 Set the required temperature and heating function.
- 2 Touch the  symbol. The rotisserie spit is switched on.

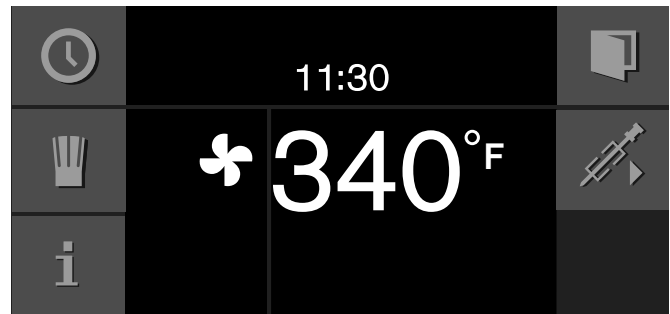

Switching off the rotisserie spit

- 1 Touch the  symbol. The rotisserie spit's drive stops.
- 2 Switch off the oven with the program selection.
- 3 Take out the grill tray with the rotisserie spit and place them on a stable, heat-resistant surface.

WARNING

Risk of burns

Use a glove to remove them.

- 4 Screw on the handle at the side to remove the rotisserie spit.

Notes

- Use the rotisserie spit at oven temperatures up to 480° F (250° C) only.
- Do not clean the drive part of the rotisserie spit in a dishwasher.

Roasting function

Only with heating type "Roaster operation":
In the pre-roast stage, the oven heats at full power for approx. 3 minutes. This way, you can cook steaks quickly.

Touch the **»»** symbol. The pre-roast stage starts up.
You can also set the pre-roast feature several times one after another.

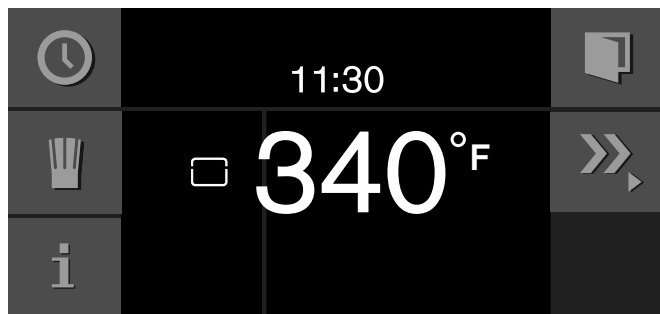

To end the pre-roast stage early, touch **»»**.

Child lock

The appliance has a child lock to make sure children cannot operate it inadvertently.

Notes

- You must set the child lock in the factory setting to "Available" (see section entitled **Factory setting**).
- If there is a power cut while the child lock is activated, it may be deactivated when the power returns.

Activating the child lock

Requirement:

Program selector is set to 0.

Touch the  symbol for at least 6 seconds.

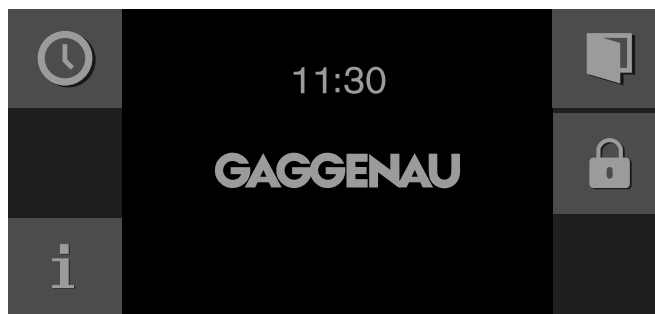

The child lock is activated. The standby screen appears. The  appears at the top of the display.

Deactivating the child lock

Requirement:

Program selector is set to 0.

Touch the  symbol for at least 6 seconds.

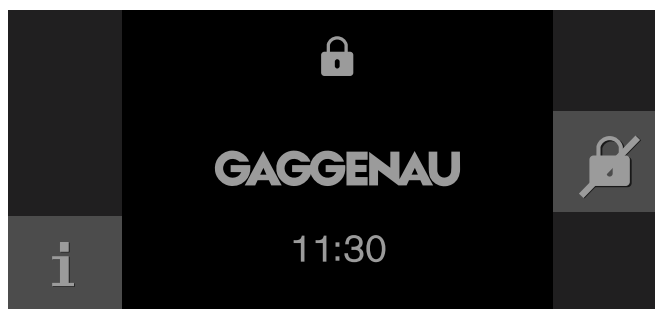











The child lock is deactivated. You can switch on the appliance in the usual manner.













Factory setting

In the factory settings, you can adapt your appliance individually.

- 1 Set the program selector to **S**.
- 2 Select "Factory setting" with the rotary selector.
- 3 Touch the ✓ symbol.
- 4 Set the required factory setting with the rotary selector.

- 5 Touch the ↘ symbol.
 - 6 Set the factory setting with the rotary selector.
 - 7 Save with ✓ or cancel with ✕ and quit the current factory setting.
 - 8 Turn the program selector to **0** to quit the factory setting menu.
- Changes are saved.

	Basic setting	Possible settings	Explanation
	Brightness	Stages 1, 2, 3, 4, 5*, 6, 7, 8	Setting display brightness
	Standby screen	On*/Off - Clock - Clock + GAGGENAU logo* - Date - Date + GAGGENAU logo - Clock + date - Clock + date + GAGGENAU logo	Appearance of the standby screen. Off: no display. Use this setting to reduce the standby consumption of your appliance. On: several displays can be set, confirm "On" with ✓ and choose the desired display with the rotary selector. The selection is displayed.
	Display screen	Minimized*/Standard	When <i>Minimized</i> is set, only the most important details are displayed after a short time.
	Touchpad color	Gray*/White	Select the color of symbols on the touchpads
	Touchpad tone	Tone 1*/Tone 2/Off	Select the signal tone when touching a touchpad
	Touchpad volume	Levels 1, 2, 3, 4, 5*, 6, 7, 8	Sets the volume of the touchpad tone
	Preheating speed/signal	Heat + signal* Quick heat + signal Heat no signal Quick heat no signal	The signal sounds when the required temperature is reached during heating. When quick heat is chosen, the required temperature is reached particularly fast.
	Signal volume	Levels 1, 2, 3, 4, 5*, 6, 7, 8	Sets the volume of the signal tone
	Time format	AM/PM / 24 h*	Time display in 24 or 12-hour format
	Time	Current time	Setting the time
	Daylight savings	Manual*/Automatic	Automatic time changeover when changing daylight savings time. If automatic: setting of the month, day and week when the time is to be changed. To be set separately for summer and winter time.

	Date format	D.M.Y* D/M/Y M/D/Y	Setting the date format
	Date	Current date	Setting the date. Switch between the year/month/day with the  symbol.
	Temperature format	°C*/°F	Set the temperature unit
	Language	German* / French / Italian / Spanish / Portuguese / Dutch / Danish / Swedish / Norwegian / Finnish / Greek / Turkish / Russian / Polish / Czech / Slovenian / Slovakian / Arabic / Hebrew / Japanese / Korean / Thai / Chinese / English US / English	Select language for the text display Note: When the language is changed, the system is restarted; this procedure takes a few seconds. Then the Factory setting menu is closed.
	Factory settings	Restore appliance to factory settings	Confirm the question "Delete all individual settings and restore appliance to factory settings?" with  or cancel with  . Note: When restoring factory settings, the individual recipes are also deleted. After restoring the factory settings, you will see the "Initial settings" menu.
	Demo mode	On/Off*	For presentation purposes only. The appliance does not heat in the demo mode, but all other functions are available. The "Off" setting must be activated for normal operation. The setting is only possible in the first three minutes after connecting the appliance.
	Sabbath mode	Not Available* / Available	Available: Sabbath mode can be set; see the section entitled <i>Sabbath mode</i> .
	Door lock	Off*/On	The door lock prevents unintentional opening of the appliance door. When "On" is set, you must touch the  symbol for several seconds before the door opens.
	Child lock	Not Available* / Available	Available: the child lock can be activated (see section entitled <i>Child lock</i>).

* Factory settings

Cleaning and maintenance

If taken care of and cleaned conscientiously, your appliance will stay beautiful and intact for a long time. Here we explain how to take care of and clean your appliance correctly.

WARNING

Risk of burns

The appliance becomes very hot. Never touch the hot inside surfaces of the oven interior or heating elements. Always allow the appliance to cool down. Keep children away.

WARNING

Risk of electrical shock

Moisture entering the appliance can cause an electrical shock. Don't use a high-pressure cleaner or steam cleaner.

WARNING

Risk of injury

Scratched glass in the appliance door can burst. Do not use any glass scrapers or strong or abrasive cleaning agents.

WARNING

Do not clean the appliance while it is still hot. Some cleaners produce noxious fumes when applied to a hot surface. Wet clothes and sponges can cause burns from steam.

Cleaning agents

Pay attention to the information in the table to ensure that the various surfaces are not damaged by incorrect cleaning agents.

Do not use any

- sharp or abrasive cleaning agents
- metal or glass scrapers to clean the glass on the appliance door.
- metal or glass scrapers to clean the door seal.
- hard abrasive pads or cleaning sponges.

Thoroughly rinse out new sponge cloths before use.

Area	Cleaning agents
Door panels	Glass cleaner: Clean with a soft cloth and dry with a microfiber cloth. Do not use a glass scraper.
Display	Wipe with a microfiber cloth or a slightly damp cloth. Do not wipe off wet.
Stainless steel	Hot soapy water: Clean with a dishcloth and dry with a soft cloth. Remove traces of limescale, grease, starch and albumin (e.g. egg white) immediately. Corrosion can form under such residues. Special stainless steel cleaning agents can be obtained from the after-sales service or from specialist shops.
Aluminum	Clean with a mild window cleaning agent. Using a window cloth or a non-fluffing microfiber cloth, wipe over the surfaces lightly in a horizontal direction.
Cooking compartment	Hot soapy water: Clean with a dishcloth and dry with a soft cloth.
Very dirty cooking compartment	Oven cleaner gel (order number 463582 from customer service or in the online shop). Please note: <ul style="list-style-type: none">● May not get on the door seal.● Soak for max. 12 hours.● Do not use on warm surfaces.● Rinse thoroughly with water.● Observe the manufacturer's instructions.
Glass cover for the cooking compartment light	Hot soapy water: Clean with a dishcloth.
Door seal Do not remove.	Hot soapy water: Clean with a dishcloth, do not scour. Do not use a metal or glass scraper for cleaning.
Core temperature probe	Wipe with a damp cloth. Do not clean in the dishwasher!
Accessories	Hot soapy water: Soak and clean with a dishcloth or brush.
Plug-in grid	Dishwasher, see chapter <i>Removing the plug-in grid</i>
Telescopic shelf (special accessories)	Hot soapy water: Clean with a dishcloth or brush. Do not soak or clean in the dishwasher.
Baking stone (special accessories)	Clean burned-on residues with a brush. Never clean the baking stone with water.

Microfiber cloth

The honeycomb-structure microfiber cloth is particularly suitable for cleaning sensitive surfaces such as glass, glass ceramics, stainless steel or aluminum (order No. 460770 available from after-sales service or in the online shop). It removes watery and greasy soiling in one go.

Removing slide-in racks

You can remove the slide-in racks for cleaning.

Removing slide-in racks

- 1 Place a dish cloth in the oven interior to protect the enamel against scratches.
- 2 Undo the knurled nuts (Figure A).
- 3 Detach the slide-in racks (Fig. B).

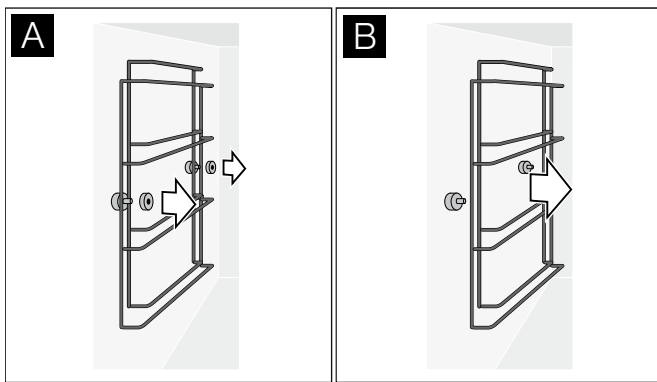

You can clean the slide-in racks in a dishwasher.

Hooking in slide-in racks

- 1 Fit slide-in racks the right way round: with the longer side pointing up. The left and right-hand racks are identical.
- 2 Tighten the knurled nuts.

Self-clean (pyrolysis)

During self-clean (pyrolysis), the oven heats up to 905 °F (485 °C). Thus, remainders from roasting, grilling or baking are burnt up and all you have to do is wipe the ash out of the interior.

Self-clean (pyrolysis) takes three hours. You can move the self-clean switch-off time (for example, if you would like it to run at night).

⚠ WARNING

During the elimination of soil during self-cleaning, small amounts of Carbon Monoxide can be created and the fiberglass insulation could give off very small amounts of formaldehyde during the first several cleaning cycles. To minimize exposure to these substances, provide good ventilation with an open window, or use a ventilation fan or hood.

Wipe out excessive spillage before self-cleaning the oven.

⚠ WARNING

Risk of fire

The appliance becomes very hot during pyrolytic self-cleaning. Never hang flammable items such as dishcloths on the door handle. Keep the front of the appliance clear. Keep children away.

⚠ WARNING

Severe health risk

The appliance becomes very hot during pyrolytic self-cleaning. The non-stick coatings on trays and forms are destroyed and toxic gases are produced. Never leave trays and forms with non-stick coatings in the oven during pyrolytic self-cleaning. Only leave enameled accessories in oven during self-clean cycle.

Do not clean parts or accessories in the self-clean oven.





Preparing self-clean (pyrolysis)

⚠ CAUTION

Fire risk! Loose food remainders, fat and roast juice can catch fire. Wipe out the oven interior with a moist cloth.

- Remove coarse soiling and food remainders from the oven.
- Clean the door seals manually, the inside of the door and the glass pane because the self-clean (pyrolysis) does not clean these parts.
- Remove all loose interior parts from the oven interior. The slide-in racks are pyrolysis-proof. There must be no objects left in the interior.
- Close the oven door.

Starting self-clean (pyrolysis)

- 1 Set the program selector to **S**.
- 2 The + symbol is displayed. Confirm with .
- 3 The turn-off time for when the self-clean (pyrolysis) will be completed is displayed. If preferred, the turn-off time can be changed with the rotary selector. Confirm with .
- 4 Remove all accessories and coarse soiling from the oven interior. Confirm with .
- 5 Start with . The cleaning time counts down on the screen. If the turn-off time was changed, the time until the self-clean (pyrolysis) starts counts down on the screen. The oven light remains off.

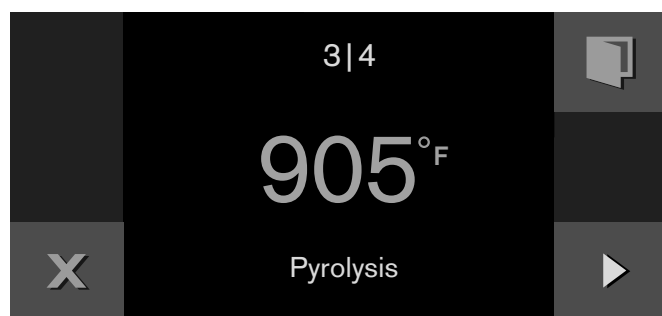

After 3 hours, a signal sounds. A message will appear on the screen. Once the appliance is cool, wipe out the remaining ash from the oven with a damp cloth.

Note: The oven door is locked for your safety. After cooling down, the door is unlocked as soon as the temperature has dropped below 390 °F (200 °C).

Cleaning accessories with self-clean (pyrolysis)

Gaggenau baking trays and grill trays are coated with pyrolysis-proof enamel. To arrive at an optimum cleaning result, you are nevertheless advised to remove all accessories from the oven before the self-clean (pyrolysis). Only this will ensure optimum heat distribution.

If you would like to remove burnt-in residues from your baking tray or your grill tray with self-clean (pyrolysis), it is imperative that you observe the following notes:

Notes

- Remove extreme soiling, roast juice and food remainders before self-clean (pyrolysis). Food remainders, grease or roast juice can catch fire during self-clean (pyrolysis).
- Only insert one baking tray or one grill tray in the lowest shelf in the oven.
- Insert the baking tray or the grill tray fully.
- Do not clean the wire rack, rotisserie spit, cast roaster, baking stone, core temperature probe or other accessories with self-clean (pyrolysis).



Troubleshooting

You can often easily eliminate problems that may occur on your own. Before calling customer service, take into account the following information.

WARNING

Risk of electric shock

Improper repairs are dangerous. Only an after-sales technician trained by us may perform repairs and may replace damaged connecting leads. Remove the mains plug or deactivate the fuse in the fuse box if the appliance is defective. Call after-sales service.

Disruption	Possible cause	Solution
Appliance not working, no display	Plug not inserted	Connect the appliance to the electricity mains
	Power failure	Check whether other kitchen appliances are working
	Fuse defective	Check in the fuse box whether the fuse for the appliance is in working order
	Operating error	Switch off the fuse for the appliance in the fuse box and switch it on again after about 10 seconds
Appliance cannot be started	Appliance door is not quite closed	Close appliance door
Appliance is not working, display is not responding.  appears in the display.	Child lock activated	Deactivate child lock (see section entitled <i>Child lock</i>)
Appliance switches off automatically	Safety deactivation: the appliance has not been operated for longer than 12 hours	Confirm the message with  , switch off the appliance and set it again.
Appliance does not heat up,  appears in the display	Appliance is in the demo mode	Deactivate demo mode in the basic settings
Error message "Exxx"		If an error message appears, turn the program selection to 0 ; if the display goes off, it was a one-time problem. If the problem occurs repeatedly or if the display stops, please contact after-sales service and inform them of the error code.

Power cut

Your appliance can bridge a power cut of a few seconds. Operation continues.

If the power cut was for a longer period and the appliance was in operation, a message appears in the display. Operation is interrupted.

Set the function selector to **0**, then the appliance can be operated again as usual.

Demo mode

The demo mode is activated if the  symbol appears in the display. The appliance does not heat up.

Briefly disconnect the appliance from the mains (switch off the domestic fuse or the circuit-breaker in the fuse box). Then deactivate the demo mode within 3 minutes in the factory setting (see section entitled **Factory setting**).

Replacing the oven lamp

You can replace the oven lamps. You can obtain replacement lamps after-sales service or from trade dealers. Use the same type of halogen bulbs only.

- Top lamp:
60 W/230 V/G9
- Side lamp: 10 W/12 V/G4

⚠ WARNING

Risk of electric shock

When you replace the oven interior lamp, the contacts of the lamp holder are live. Before replacing the lamp, remove the mains plug or deactivate the fuse in the fuse box.

Note: Always use a dry cloth to remove the halogen lamp from its packaging. This lengthens the lamp's useful life.

Replacing the top oven lamp

- 1 Undo the screw on the lamp cover. The lamp cover folds down.
- 2 Take out the halogen lamp. Insert the new halogen lamp.
- 3 Fold up and screw down the lamp cover.
- 4 Switch on the fuse in the fuse box again.

Replacing the side oven lamp

- 1 Place a dishcloth in the oven to avoid damage.
- 2 Undo the knurled screws on the slide-in rack. Remove the slide-in rack.
- 3 Press the top retaining spring to the side. Remove the glass cover.
- 4 Take out the halogen lamp. Insert the new halogen lamp.
- 5 Insert the glass cover at the bottom into the retaining spring and latch it at the top. The beveled side of the glass cover must point toward the oven.
- 6 Remove the dishcloth from the oven.
- 7 Switch on the fuse in the fuse box again.

Replacing the glass cover

The glass cover in the oven must be replaced if it is damaged. You can obtain covers from after-sales service. Always specify the E number and the FD number of your appliance.

Customer service

If your appliance needs repairs, our customer service is there for you. We work hard to help solve problems quickly and without unnecessary service calls, getting your appliance back up and running correctly in the least amount of time possible.

When you call, please indicate the product number (E-Nr.) and serial number (FD-Nr.) so that we can support you in a qualified manner. You will find the type plate with these numbers on the bottom of the appliance. To avoid having to search for a long time when you need it, you can enter your appliance data and the customer support telephone number here.

E-Nr.

FD-Nr.

Customer Service ☎

Please read the use and care instructions provided with your appliance. Failure to do so may result in an error in using the appliance. This could result in a service call that instead of fixing a mechanical issue is only needed for customer education. Such calls are not covered by the appliance warranty.

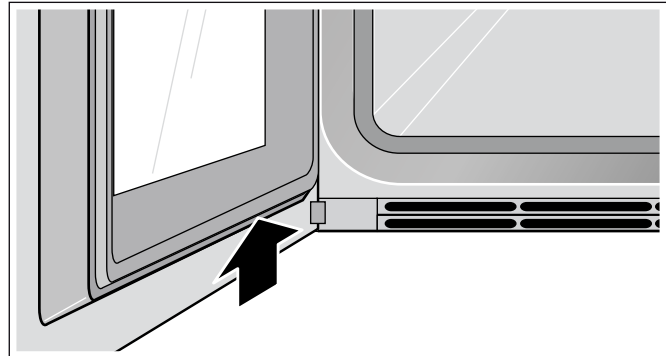

Please find the contact data of all countries in the enclosed customer service list.

To book an engineer visit and product advice

USA 877 442 4436
toll-free

CANADA 800 828 9165

You can rely on the manufacturer's expertise. Rest assured that the repair will be handled by trained service technicians who have the original replacement parts for your appliance.

Tables and tips

Notes

- The specified values are for your orientation. The temperature and duration depend on the quality and condition of foods.
- Always preheat the oven. This ensures you achieve the best cooking results. The specified cooking times apply to a preheated appliance.
- Pay attention to only opening the door of the preheated oven briefly and to filling the appliance swiftly.
- Temperature ranges are specified in the tables. We recommend that you begin for the first time with the lowest temperature. If required, set it higher the next time. A lower temperature produces more even browning.
- The recommended mode is printed in bold.

Baking table

- We advise you to use dark, metal bake pans because they absorb heat better.
- To find out when your cake is ready, pierce it at the highest point with the small wooden stick at the end of the baking time. The cake is finished if dough no longer sticks to the stick.
- Baked items using yeast come out best when using the convection mode.
- Raising dough (proofing):
 - Set the dough proofing mode. The basic temperature setting is 100° F (38° C).
 - Set 100 - 104° F (38-40° C) for large volumes (e.g. bread). This will ensure that the dough rises evenly from the center to the edge.
 - You can enter 104 - 113° F (40-45° C) for small items (such as Schneckennudeln (Swabian twirls) or bread rolls).

Baked items	Shelf level with 4 levels (with 5 levels)	Convection Temperature in °F (°C)	Economy Temperature in °F (°C)	Convection + bottom heat Temperature in °F (°C)	Top + bottom heat Temperature in °F (°C)	Baking time in min.
Swiss roll	2 (3)				410 (210)	7 - 9
Cake base	2 (3)				330 - 345 (165 - 175)	30 - 35
Fruit cake on a yeast batter	2 (3)	330 (165)			330 - 345 (165 - 175)	40 - 45
Fruit cake on a shortcake base	2 (3)	330 (165)	330 (165)	330 (165)	330 - 345 (165 - 175)	40 - 45
Small puff pastry items	2 / 1+3* (3 / 2+4*)	355 (180)	355 (180)		375 (190)	15 - 20
Cheesecake (high)	2 (3)	330 (165)	330 (165)	330 (165)	330 - 340 (165 - 170)	90 - 100
Open-cheese sandwiches (flat)	2 (3)	330 (165)	330 (165)	330 (165)	330 - 345 (165 - 175)	45 - 50
Sponge cake (round)	2 (3)	320 - 340 (160 - 170)	320 - 345 (160 - 175)		340 - 345 (170 - 175)	50 - 60
Cakes	2 (3)	320 - 340 (160 - 170)	320 - 345 (160 - 175)		340 - 345 (170 - 175)	50 - 60
Yeast cake (high)	1 (2)	320 - 345 (160 - 175)			330 - 345 (165 - 175)	40 - 50

* In the Economy and convection operating modes, you can bake on several levels at the same time.

** Pre-heat the appliance to the specified temperature. When putting in the food to be cooked, switch back to the second temperature specification.

Baked items	Shelf level with 4 levels (with 5 levels)	Convection Temperature in °F (°C)	Economy Temperature in °F (°C)	Convection + bottom heat Temperature in °F (°C)	Top + bottom heat Temperature in °F (°C)	Baking time in min.
Cookies	2 / 1+3* (3 / 2+4*)	320 - 345 (160 - 175)	320 - 345 (160 - 175)		330 - 340 (165 - 170)	15 - 20
Hefezopf	2 (3)	330 (165)			330 - 340 (165 - 170)	30 - 40
Sheet cake (dry topping)	2 (3)	330 - 340 (165 - 170)	330 - 340 (165 - 170)		330 - 340 (165 - 170)	40 - 50
Sheet cake (wet topping)	2 (3)	330 - 340 (165 - 170)	330 - 340 (165 - 170)	340 (170)	330 - 340 (165 - 170)	40 - 50
Cream puffs	2 / 1+3* (3 / 2+4*)	355 (180)	355 (180)		355 - 375 (180 - 190)	20 - 25
Multigrain bread	2 (3)	390/340** (200/170**)			410/340** (210/170**)	40 - 50

* In the Economy and convection operating modes, you can bake on several levels at the same time.

** Pre-heat the appliance to the specified temperature. When putting in the food to be cooked, switch back to the second temperature specification.

Baking tips and tricks

What to do if...	The solution
... your cake baked on a tray is too light at the bottom?	Insert the cake one level lower and take accessories that you don't need out of the oven.
... your cake baked in a tin is too light at the bottom?	Do not insert the cake pan in the oven on the tray, but on the rack.
... your cake/cookies are too dark at the bottom?	Insert the cake/cookies at a higher level.
... your cake is too dry?	Set the oven temperature slightly higher. Preheat the oven.
... your cake is doughy inside or meat is not done inside?	Set a slightly lower baking or roasting temperature. Note: you cannot shorten baking or roasting times by increasing temperatures. It is better to choose a slightly longer baking or roasting time if cake dough is to rise longer.
... your tin-baked or loaf cake is too dark at the back when using hot air?	Don't place the cake pan directly in front of the oven's rear wall, but in the center.
... the cake collapses?	Next time, use less liquid or set the oven temperature lower by 10°C (approx. 50 °F). Pay attention to the mixing times specified in the recipe. Do not open the oven door too early.
... the cake has risen in the middle and is lower at the sides?	Grease the springform's edge. After baking, loosen the cake carefully with a knife.
... your cake is too dark at the top?	Insert it at a lower level, choose a lower temperature and bake the cake slightly longer.
... your cake is too dark at the bottom?	Insert it at a higher level and choose a lower temperature the next time.
... your fruit flan becomes too light at the bottom and fruit juice overflows?	You are best advised to use the deeper grill tray for baking next time.
... your cake is too dry at the bottom?	Use a toothpick to pierce small holes in the finished cake. Then trickle fruit juice or something alcoholic over it. The next time, choose a temperature 10°C (approx. 50 °F) higher and shorten the baking time.

What to do if...	The solution
... your bread or cake looks good (done) from the outside, but is doughy or too moist on the inside?	Next time, use a little less liquid and bake a little longer at a lower temperature. In the case of cakes with a moist topping, pre-bake the base first, scatter almonds or breadcrumbs over it and then add the topping. Pay attention to recipes and baking times.
... you have baked on several levels and the result on the top tray is darker than on the lower one?	Choose a slightly lower temperature and the result will be evenly brown. Trays you have inserted at the same time need not be finished at the same time. Leave the bottom trays to bake a little longer for 5 - 10 minutes or insert them earlier.
... cookies do not come off the tray?	Briefly place the tray in the oven again and immediately remove the cookies.
... your cake does not come off when you turn it out?	Carefully loosen the edge with a knife. Turn out the cake again and cover the tin several times with a wet, cold cloth. Next time, grease the tin well and additionally scatter breadcrumbs into it.

Roasting table

- You can basically use any heat-resistant cookware. Place cookware in the middle of the rack. For large roasts, you can also use the grill tray.
- You can remove the side slide-in racks to prepare bulky food. Place the wire rack directly on the bottom of the oven and then place the food or the roaster on the wire rack. Do not place the food or the roaster directly on the enameled bottom.
- When removing it, place glass cookware on a dry dishcloth or rack and not on a cold or wet surface. The glass could crack.
- Once the roast is finished, you should leave it for another 10 minutes in the switched off, closed oven. This way, meat stays juicier.
- Poultry becomes particularly crispy brown if you coat it with butter, salty water, dripped off fat or orange juice towards the end of the cooking time.
- In the case of duck or goose, pierce the skin under the wings to allow the fat to drip off.
- Use the insert rack (depending on the version, an accessory or special accessory) in the grill tray for roasting. If you add a little water to the grill tray, the meat juice will be collected and the oven will stay cleaner.

Dishes	Shelf level with 4 levels (with 5 levels)	Convection Temperature in °F (°C)	Full surface grill + circulated air Temperature in °F (°C)	Top + bottom heat Temperature in °F (°C)	Cooking time in min.	Core temperature in °F (°C)
Beef						
Beef roast (1.5 kg)*	2 (3)	355 (180)		355 (180)	60 - 90	
English roast beef (1.5 kg)	2 (3)	445/355** (230/180**)	445/355** (230/180**)		45 - 50	115 - 120 (45 - 50)
Medium roast beef (1.5 kg)	2 (3)	445/355** (230/180**)	445/355** (230/180**)		60 - 70	130 - 150 (55 - 65)
Well-done roast beef (1.5 kg)	2 (3)	445/355** (230/180**)			90 - 100	160 - 175 (70 - 80)
Pork						
Pork roast (1.5 kg)	2 (3)	445/355** (230/180**)	445/355** (230/180**)		60 - 70	170 - 175 (75 - 80)
Pork roast with crust (1.5 kg)	2 (3)	355 - 390 (180/200***)	355/390*** (180/200***)		60 - 70	170 - 175 (75 - 80)

* First cook meat in a casserole on the burner.

** Brown the meat at high temperature, after 15 - 20 min. switch back to a lower temperature.

*** Cook meat at a low temperature, set the temperature higher for the last 15 - 20 min.

Dishes	Shelf level with 4 levels (with 5 levels)	Convection Temperature in °F (°C)	Full surface grill + circulated air Temperature in °F (°C)	Top + bottom heat Temperature in °F (°C)	Cooking time in min.	Core temperature in °F (°C)
Smoke-cured pork (1.5 kg)	2 (3)	355/320** (180/160**)			40 - 50	150 - 160 (65 - 70)
Pork knuckles	2 (3)	300/390*** (150/200***)	300/390*** (150/200***)		50 - 60	175 - 185 (80 - 85)
Rolled pork	2 (3)	445/355** (230/180**)	445/355** (230/180**)		60 - 70	170 - 175 (75 - 80)
Veal						
Veal roast	2 (3)	445/355** (230/180**)		445/355** (230/180**)	60 - 70	170 - 175 (75 - 80)
Veal knuckles	2 (3)	300/355*** (150/180***)	300/355*** (150/180***)		50 - 60	80 (75)
Veal loin	2 (3)	320 - 340 (160 - 170)			20	160 - 170 (70 - 75)
Stuffed breast of veal*	2 (3)	250 - 265 (120 - 130)			120	170 - 175 (75 - 80)
Game						
Roast game*	2 (3)	340 - 355 (170 - 180)			60 - 90	
Leg of venison*	2 (3)	340 - 355 (170 - 180)			60 - 80	170 - 175 (75 - 80)
Saddle of venison	2 (3)	330 - 350 (165 - 175)		340 - 355 (170 - 180)	20 - 25	150 - 160 (65 - 70)
Leg of lamb*	2 (3)	355 - 390 (180 - 200)			35 - 45	150 - 170 (65 - 75)
Poultry						
Duck (2 - 3 kg)	2 (3)	320/375 (160/190***)		320/375*** (160/190***)	100 - 120	175 - 185 (80 - 85)
Duck breast	2 (3)	320 (160)		320 (160)	15 - 20	160 (70)
Goose (2 - 3 kg)	2 (3)	320/375 (160/190***)		320/375*** (160/190***)	100 - 120	185 - 195 (85 - 90)
Chicken (3 - 4 kg)	2 (3)	160/190***		160/190***	120 - 180	85 - 90
Roast chicken	2 (3)	355 (180)	355 (180)		50 - 60	85
* First cook meat in a casserole on the burner.						
** Brown the meat at high temperature, after 15 - 20 min. switch back to a lower temperature.						
*** Cook meat at a low temperature, set the temperature higher for the last 15 - 20 min.						

Roasting tips and tricks

What to do if...	The solution
... the roast has gone dark and the crust is burnt in places?	Check the insertion level and the set roasting temperature.
... the roast looks good, but the sauce has baked on?	Choose smaller roasting cookware the next time and add more liquid.
... the roast looks good, but the sauce is too light and watery?	Choose larger roasting cookware the next time and use less liquid.
... the table does not contain any data for the weight of the roast?	Choose the data according to the next lowest weight and extend the time.

Grilling table

⚠ CAUTION

Only grill with the oven door closed.

- For roasting use the wire rack that fits the grilling tray (accessory or special accessory, depending on the version). Pour a small amount of water into the grilling tray to collect dripping fat and keep the oven clean.
- The pieces of meat should be evenly thick (at least 1 - 2 in (2 - 3 cm)). Thus they will brown evenly and remain juicy inside. Do not salt steaks before grilling. Place the food directly on the wire rack.

Dishes	Shelf level with 4 levels (with 5 levels)	Temperature in °F (°C)	Full surface grill in min. 1st side/2nd side	Full surface grill + circulated air in min. 1st side/2nd side	Total cooking time in min.
Pork belly in slices	3 (4)	355 - 390 (180 - 200)	6 / 4	5 / 5	10
Shish kebab	3 (4)	375 (190)		8 / 8	16
Bratwurst	3 (4)	390 (200)	5 / 4		9
Merguez (grilling sausage)	3 (4)	390 (200)		6 / 6	12
Roast chicken*	2 (3) do not preheat	355 (180)		30 / 30	60
Chicken legs	3 (4)	355 (180)	20 / 20	15 / 15	30 - 40
Spare Ribs	3 (4)	355 - 390 (180 - 200)	15 / 15	12 / 12	24 - 30
Pork knuckles**	2 (3)	300/390 (150/200)			50 - 60
Trout	3 (4)	355 - 390 (180 - 200)	8 / 8		16
Vegetable skewers	3 (4)	390 (200)	7 / 7		14
Shrimp skewers	3 (4)	350 (175)	7 / 7		14
Cooking "au gratin"					
Open-faced sandwiches	3 (4)	375 (190)			5 - 7
Crème caramel***	4 (5) do not preheat	480 (250)			
Crème brûlée***	4 (5) do not preheat	480 (250)			
Cake with meringue***	3 (4) do not preheat	480 (250)			
* For appliances with a rotary spit, use the rotary spit in grill mode.					
** Do not turn the pork knuckles. Set the temperature high for the last 15 - 20 min.					
*** For this food, cook "au gratin" to the desired degree of browning.					

Thawing

- Set the defrosting mode.
- Put the grill rack with the frozen food on the second level (with 5 levels on the third level), then insert the grill pan to catch the defrosting liquids.
- Defrost large pieces of meat (roasts, chickens, etc.) at 115 - 120° F (45 - 50°C) so that the outer part does not get cooked. Small or flat pieces can be defrosted at 120 - 130° F (50 - 55°C.)
- Remove the food from the packaging before defrosting.
- Only defrost the quantity that you need right away.
- Please consider: defrosted food will not last as long as frozen food and will spoil more quickly than fresh food. Prepare defrosted food immediately and cook it thoroughly.

WARNING

Health risk

When defrosting food from animal sources, you must remove the liquid that escapes during defrosting. It must never come into contact with other food. Bacteria could be transferred. Insert the grill pan under the food. Throw away the liquid that collects from defrosting meat and poultry, then clean the sink thoroughly and rinse it with a lot of water. Clean the grill pan in hot soapy water or in the dishwasher. After defrosting, operate the oven for 15 minutes using convection at 355° F (180°C).

Acrylamide in foodstuffs

Which foods are affected?

Acrylamide is mainly produced in grain and potato products that are heated to high temperatures, such as potato crisps, chips, toast, bread rolls, bread, fine baked goods (biscuits, gingerbread, cookies).

Tips for keeping acrylamide to a minimum when preparing food

General	Keep cooking times to a minimum. Cook meals until they are golden brown, but not too dark. Large, thick pieces of food contain less acrylamide.
Baking	With convection max. 355° F (180°C).
Cookies	Egg or egg yolk reduces the production of acrylamide. Spread out a single layer evenly on the baking tray.
Oven fries	Cook at least 400 g at once on a baking tray so that the fries do not dry out.

Gaggenau

BSH Home Appliances Ltd.
1901 Main Street, Suite 600
Irvine, CA 92614
+1.877.442.4436
USA
www.gaggenau-usa.com

Gaggenau Hausgeräte GmbH

Carl-Wery-Straße 34
81739 München
GERMANY

GAGGENAU

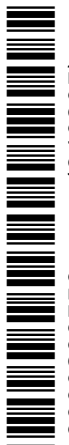

9000866756 en-us (940207)