



RF 491 705

Fully integrated
Width 36" (91.4 cm)

Included accessories

- 1 ice cube scoop
- 1 ice storage container, large
- 1 Accessory for side-by-side installation
- 1 supply hose, 47" (1.2 m) with 1/4" male compression fitting (standard icemaker connector)

Installation accessories

RA 421 914

Stainless steel door panel with handle
For 36" (91.4 cm) wide appliances, panel thickness 3/4".

RA 423 140

Side trims, long.

RA 425 110

Stainless steel handle for freezer door.
With 3 mounts, length 44 1/2" (1.131 mm).

RA 428 914

Stainless steel door panel, handleless
For 36" (91.4 cm) wide appliances, panel thickness 3/4".

RA 460 012

Additional side heating element 110 V. Required if appliances are installed with a distance greater than 5/8" and less than 6 5/16" next to each other and for all built-in situations in a very humid environment. Not required if appliances are installed more than 6 5/16" apart from each other.

RA 460 020

Connecting element for vertically split appliance fronts (for a flush front).

RA 464 914

Ventilation grill stainless steel
For RF 491 36" (91.4 cm) wide appliances, with integrated water filter.

Optional accessories

RA 450 000

Mechanical particle filter.

RA 450 022

Activated charcoal filter for water filter system including saturation indicator.

Vario 400 series freezer column

RF 491

- Stainless steel interior with solid anthracite aluminum elements
- Warm white and glare-free LED light spots
- Opening assist for door with two options:
 1. Push-to-open function for integration into handleless cabinet front
 2. Pull-to-open function to facilitate opening the door using a handle
- The drawers in the RC and RF models are positioned at the same height. With side-by-side installation, the glass shelves and door racks can be aligned on the same level
- Material and aesthetics of interior as for RC model
 - Glass shelves
 - Solid anthracite aluminum door racks
 - Flat stainless steel inner door
- Almost invisible rail system for shelves and door racks for flexible positioning
- Integrated ice maker with fixed inlet water connection
- TFT touch display
- ENERGY STAR® certified
- Sabbath mode certified by Star-K
- Net volume 19.4 cu.ft.

Operation

TFT touch display operation.
Clear text display.

Features

Dynamic cold air distribution.
Automatic defrosting with defrost water evaporation.
Cushioned door closing system.
Sabbath mode certified by Star-K. When sabbath mode is active, the appliance can only be opened using a handle.
Open-door and malfunction alarm.

Home network integration for digital services (Home Connect) wireless via WiFi. The use of the Home Connect functionality depends on the Home Connect services, which are not available in every country. For further information please check: home-connect.com.

Freezing

No-Frost technology with fast freezing at -22°F (-30°C).
Temperature adjustable from 3°F to -11°F (-16°C to -24°C).
4 safety glass shelves, white glass, 3 of which are individually adjustable in height.
2 fully extendable drawers with transparent front.
Brilliant LED light spots with warm white, glare-free light.
Flat door rail system with fully flexible positioning of door racks.
4 height-adjustable door racks.
Net volume 19.4 cu.ft.

Ice maker

Integrated in the freezer compartment, with fixed inlet water connection.
Particle filter for water inlet, integrated in ventilation grill area.
Can be switched off.

Ice cube production approx. 3.1 lbs. (1.4 kg)/24 h.
Removable ice storage container with approx. 5.5 lbs. (2.5kg) capacity.

Consumption data

Energy consumption
528 kWh/year.
Noise level 42 dBA.

Planning notes

Flat hinge.
Door hinge right, reversible.
Door opening angle of 115°, fixable at 90°.
Due to limitations in use, it is not recommended to install a freezer next to a wall which requires a door angle of 90°. Otherwise the drawer bins will be restricted.
In case of door opening angle of 90° the standard ice storage container cannot be removed. A small ice storage container (RA 448 220) is available to ensure access. This change must be done prior to fixing the door.
Max. door panel weight: 95 lbs. (43 kg).
Shut-off valve for water connection must be planned next to the appliance and always be accessible.
If the water pressure exceeds 116 psi, connect pressure relief valve between water tap and hose set.

Rating

Total rating: 1.44 kW/24h.
Total Amps: 15 A.
120 V / 60 Hz
Connecting cable 118" (3m) detachable.
Water inlet.
Supply hose 47" (1.2 m) with 1/4" male compression fitting (standard icemaker connector).
Water pressure 29 to 116 psi.

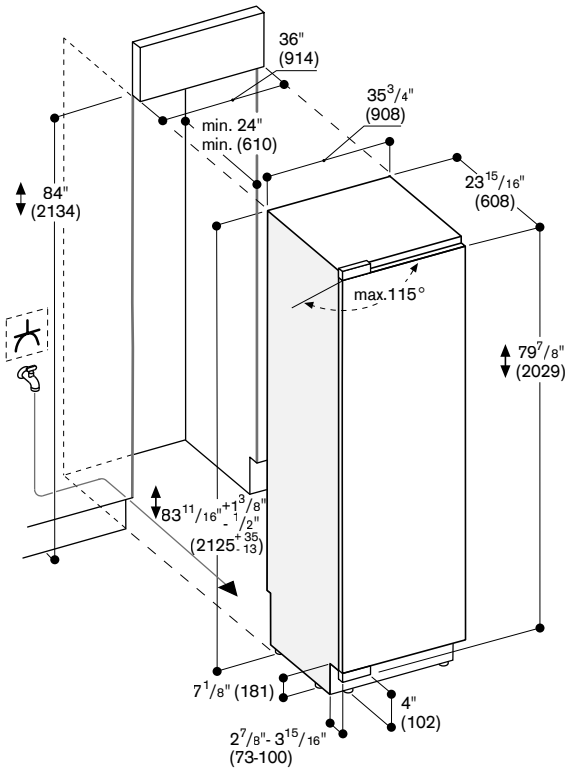

The door face dimensions are designed for a maximum gap of 1/8" (3 mm).