



RB 282 705

Two-door bottom freezer
without ice maker
Fully integrated
Width: 22 1/4" (56 cm)

Included accessories

- 2 ice packs
- 3 egg trays
- 1 wine and champagne rack
- 1 ice cube tray with lid

Optional accessories

RA 430 100

Storage container with transparent lid, anthracite

200 series two-door bottom freezer RB 280

- 4 climate zones incl. two fresh cooling drawers close to 32 °F
- Height adjustable safety glass shelves
- Door bins with aluminum profiles
- Cushioned door closing system allowing a soft and controlled door closure
- ENERGY STAR® certified
- Total unit gross capacity 8.3 cu.ft.

Operation

Electronic precision temperature control with digital temperature display. Touch keys.

Technical Features

Automatic defrosting with defrost water evaporation.
Soft-closing door closing system from 20° door opening angle, integrated in door hinge.
Open-door and malfunction warning system.

Home network integration for digital services (Home Connect) wireless via WiFi. The use of the Home Connect functionality depends on the Home Connect services, which are not available in every country.

For further information please check: home-connect.com.

Cooling compartment

Fast cooling.
Temperature adjustable from 35 °F to 46 °F (+2 °C to +8 °C).
2 safety glass shelves, height adjustable, of which 1 is extendable.
1 integrated shelf.
Wine and champagne rack for 4 bottles, can be completely folded.
1 large door rack with aluminium profile for bottles with flexible bottle holder.
1 door rack with aluminium profile.
Bright interior lighting with integrated glare-free side light element.

Fresh cooling close to 32°F (0°C)

1 fully extendable fresh cooling drawer close to 32°F (0°C), illuminated.
Humidity can be adjusted manually.
Ideal for fruit and vegetables.
Ideal for meat, fish and poultry.

Freezer compartment

No-frost technology with fast freezing.
Temperature adjustable from 3 °F to -11 °F (-16 °C to -24 °C).
Defrost assistance.
Storage time after a malfunction 8 h.
3 freezer drawers, 1 of which extra large.
2 safety glass shelves.

Consumption data

Energy consumption 232 kWh/year.
Noise level 37 dB(A) re 1 pW.

Planning notes

Flat hinge.
Door hinge right, reversible.
Door opening angle of 115°, fixable at 90°.
Max. door panel weight:
Upper door 40 lb (18 kg).
Lower door 40 lb (18 kg).

Rating

Total rating 90 W.
Total Amps: 10 A.
Connecting cable 59" with ground plug.

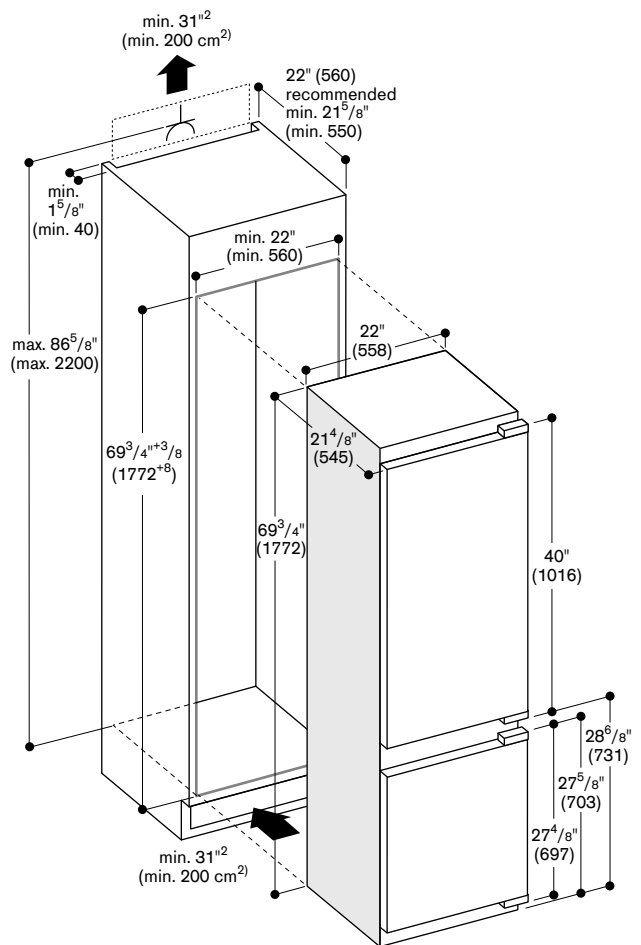

Numbers indicated
inside parenthesis () = mm

www.gaggenau.com/us
Revised: June 2021