



MW 420 620
Stainless steel

Built-in microwave drawer
MW 420

- Built-in microwave drawer, perfect for kitchen islands, under counter and wall applications
- Can be installed perfectly flush in any standard depth cabinetry
- Handleless microwave drawer
- One touch to open and close
- Sensor cooking mode for easy cooking
- 950 W microwave power
- Net volume 1.2 cu.ft.

Oven interior dimensions:
W 17 5/16" x H 7 1/8" x D 16 9/16"
Appliance dimensions:
W 23 7/8" x H 16 5/16" x D 23 3/8"

Cooking modes
10 Cooking modes, including melt, soften, keep warm.

Operation
One touch to open and close the microwave drawer.

Features
Glass touch control panel and an interactive visual display.
Digital display with scrolling text.
Interior capacity accommodates 9" x 13" pans and cups up to 7" in height or 20 oz.
Adjustable cooking time up to 99 minutes and 99 seconds.
Keep warm setting allows food to be kept warm for up to 99 minutes.
Sensor cooking mode controls humidity and automatically adjusts cooking level and cooking time.
Quick defrost program.
Sensor reheat program.
Popcorn sensor cooking.
Kitchen Timer.
Maximum microwave output power 950 W.

Safety
Control panel lock.

Planning notes
The built-in microwave drawer can be installed using a standard or flush (inset) installation (see adjacent drawings).
Cabinet base support requirements: 100 pounds.
Microwave drawer can be installed below an oven but requires a clearance of at least 2".

Rating
Total rating: 950 W.
Total Amps: 15 A.
120 V / 60 Hz
Connecting cable 48" with grounding plug.

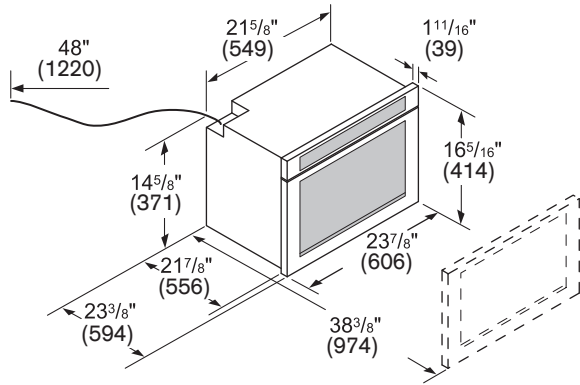

Flush installation

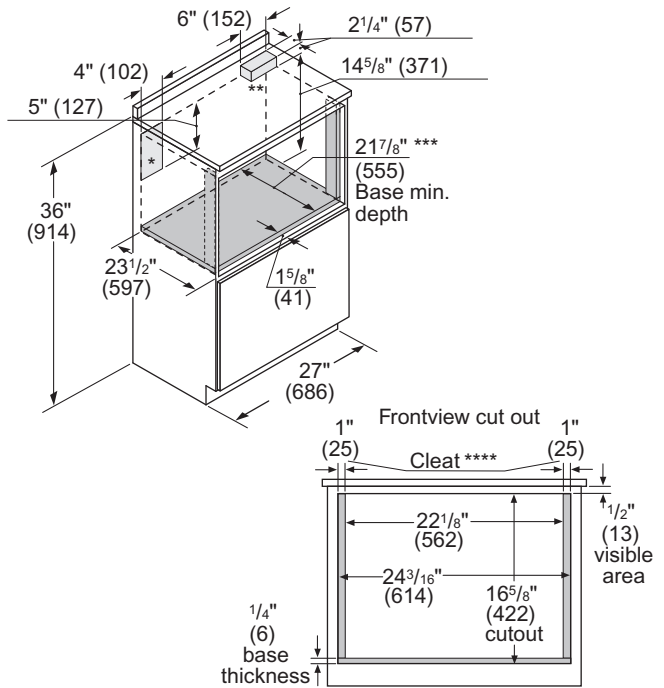

Standard installation

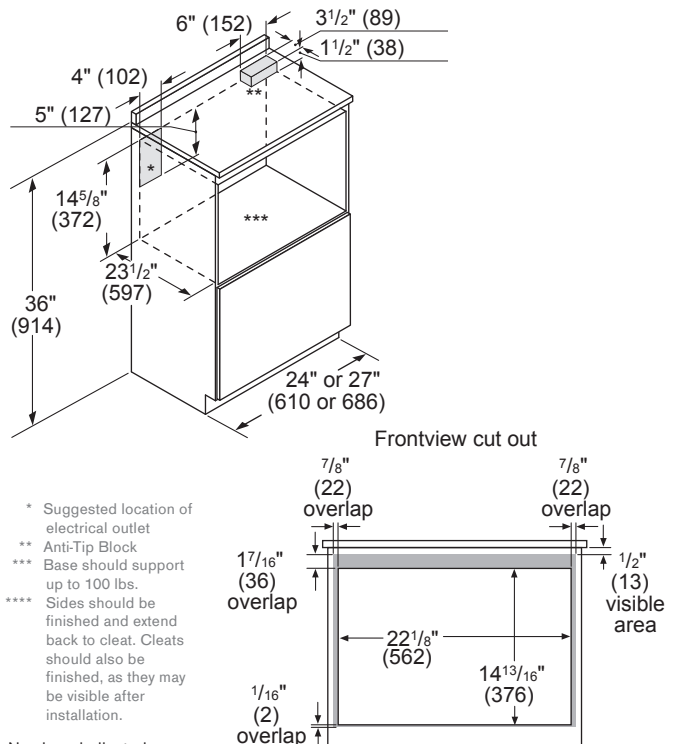

- * Suggested location of electrical outlet
- ** Anti-Tip Block
- *** Base should support up to 100 lbs.
- **** Sides should be finished and extend back to cleat. Cleats should also be finished, as they may be visible after installation.

Numbers indicated inside parenthesis () = mm