



VI 414 613

Stainless steel frame
Width 15" (38 cm)

Installation accessories

In combination of several Vario cooktops or VL 414 downdraft, connecting strips must be used. Choose respective VA 420 strip from one of the below, depending on type of installation.

VA 420 000

Connection strip for combination with other Vario 400 series appliances for **flush mounting**.

VA 420 010

Connection strip for combination with other Vario 400 series appliances for **surface mounting**.

Optional accessories

GP 900 004

Stainless steel frying sensor pan
Non-stick coating, ø 11".

WP 400 001

Wok pan made of multiple-layer material
With round bottom and handle, ø 14 3/8", 6.3 qt., height 4".

WZ 400 000

Wok support ring for wok pan
For use with VI 414 Vario induction wok and VI 492 Vario flex induction cooktop only.

Vario 400 series induction wok

VI 414

- 12 5/8" cooking zone with booster function
- Ideal for round-bottomed wok using wok ring attachment
- Frying sensor function for temperature control in pans
- Easy control of all functions with bi-colored display
- Solid stainless steel control knob
- Precision-crafted 3 mm stainless steel
- For surface mounting with a visible edge or for flush mounting
- Can be combined with other Vario 400 series products

Cooking zones

1 induction cooking zone ø 8 1/4" (21 cm) (2,200 W, with booster 3,700 W), automatically switches to ø 10 1/4" (26 cm) (2,600 W, with booster 3,700 W), and to ø 12 5/8" (32 cm) (3,300 W, with booster 3,700 W)

Operation

Control knobs with illuminated ring, cooking zone and output level markings.

Electronic power control in 12 output levels.

User friendly control with bi-colored display (white / orange)

Features

Frying sensor function.
Booster function.
Stopwatch.
Short-term timer.
Options menu.
Power management.
Cooktop-based ventilation control (with suitable hood).

Home network integration for digital services (Home Connect) wireless via WiFi. The use of the Home Connect functionality depends on the Home Connect services, which are not available in every country. For further information please check: home-connect.com.

Safety

Operation indicator.
Pot detection.
2-stage residual heat indication.
Safety shut-off.

Planning notes

Depending on the type of installation – surface- / or flush-mounted – the specific location of the cut-out and the control knob positions may vary. The drawing "Installation of the control knob" must be observed if the panel is more than 1" thick (there must be a recess at the rear).

If combining several Vario 400 series appliances, a connection strip VA 420 must be placed between the appliances. Depending on the type of installation, the corresponding connection strip must be provided. The weight bearing capacity and stability, in the case of thin countertops in particular, must be supported using suitable substructures. Take into account the appliance weight and additional loads.

Additional instructions for flush mounting:

Installation is possible in countertops made of stone, synthetics or solid wood.

Heat resistance and watertight sealing of the cut edges must be observed. Concerning other materials please consult the countertop manufacturer. The groove must be continuous and even, so that uniform placing of the appliance on the gasket is ensured. Do not use discontinuous lining. The joint width may vary due to size tolerances of the combinations and of the countertop cut-out.

If installing several Vario appliances in individual cut-outs allow for a minimum distance of 2" between the individual cooktops.

Operates with magnetic (induction) iron pots and pans only. For an optimal heat distribution, the use of flat bottom cookware is recommended.

Immersion depth depending on installation situation, 2 5/8" for surface-mount or 2 3/4" for flush-mount. Front panel thickness 5/8" – 1". Appliance can be snapped into the countertop from above. Appliance weight: approx. 22 lbs.

Rating

Total rating: 3.6 kW.
Total Amps 15 A.
208/220–240 V / 60 Hz
Plan for a 59" connecting cable without plug (hardwire required).

Surface-mount Installation

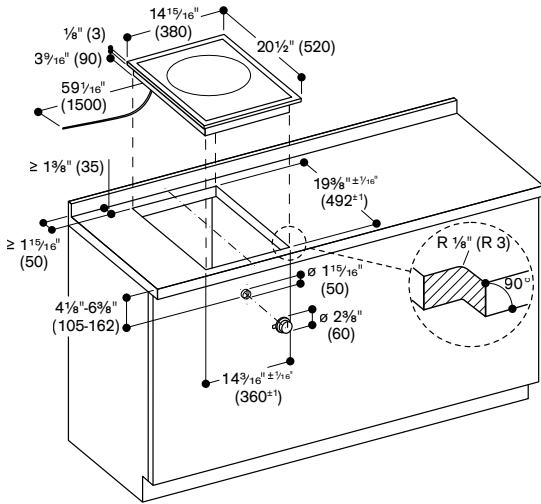

Flush-mount Installation

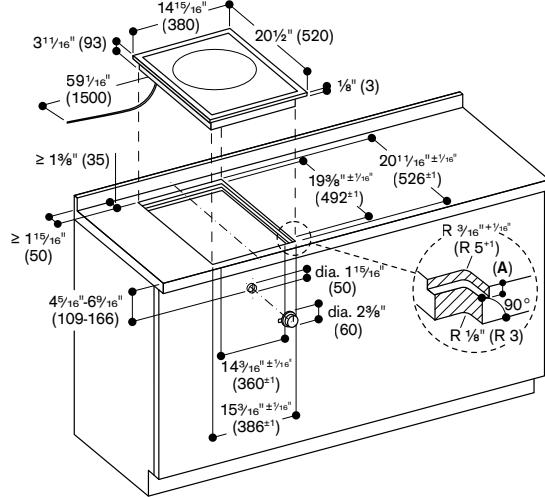

A: 1/8" (3.5^{0.5})

Installation of the control knob; surface-mount installation

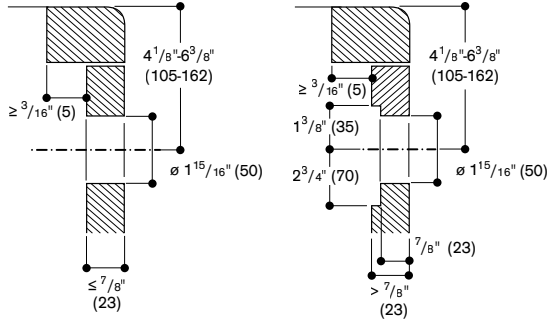

Installation of the control knob; flush-mount installation

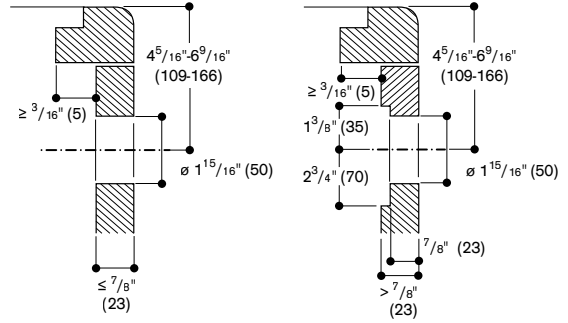

View from above

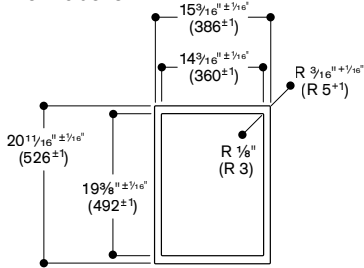

Longitudinal section

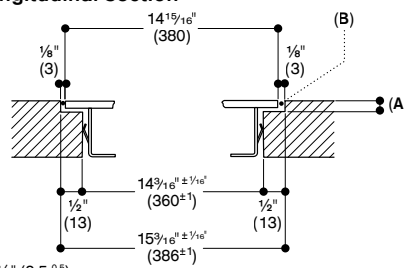

A: 1/8" (3.5^{0.5})
B: Fill with silicone

Cross-section

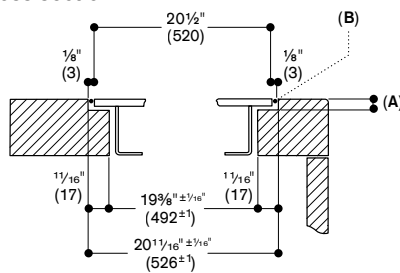

A: 1/8" (3.5^{0.5})
B: Fill with silicone

When installing with appliance cover, pay attention to the deeper cut-out and the front and rear groove width.