



## RC 492 704

Fully integrated  
Width 36" (91.4 cm)

## Included accessories

1 egg holder with lid

## Installation accessories

### RA 421 914

Stainless steel door panel **with handle**  
For 36" (91.4 cm) wide appliances,  
panel thickness ¾".

### RA 423 140

Side trims, long.

### RA 425 110

Stainless steel handle for  
refrigerator door.

With 3 mounts, length 44 ½" (1.131 mm).

### RA 428 914

Stainless steel door panel, **handleless**  
For 36" (91.4 cm) wide appliances,  
panel thickness ¾".

### RA 460 000

Accessory for side-by-side installation.  
Not required if appliances are installed  
more than 6 ⅝" apart from each other.  
Included in delivery for RF and RW

### RA 460 012

Additional side heating element  
110 V. Required if appliances are  
installed with a distance greater than  
¾" and less than 6 ⅝" next to each  
other and for all built-in situations in a  
very humid environment. Not required  
if appliances are installed more than  
6 ⅝" apart from each other.

### RA 460 020

Connecting element for vertically split  
appliance fronts (for a flush front).

### RA 464 911

Ventilation grill stainless steel  
For 36" (91.4 cm) wide appliances.

## Optional accessories

### RA 430 100

Storage container with transparent lid,  
anthracite

## Vario 400 series refrigeration column RC 492

- Stainless steel interior with solid anthracite aluminum elements
- Warm white and glare-free LED light spots
- Opening assist for door with two options:
  1. Push-to-open function for integration into handleless cabinet front
  2. Pull-to-open function to facilitate opening the door using a handle
- The drawers in the RC and RF models are positioned at the same height. With side-by-side installation, the glass shelves and door racks can be aligned on the same level
- Flat stainless steel inner door
- Almost invisible rail system for shelves and door racks for flexible positioning
- Solid anthracite aluminum door racks
- One fresh cooling drawer 32°F (0°C) with manually adjustable temperature and one fresh cooling drawer with manually adjustable humidity
- TFT touch display
- ENERGY STAR® certified
- Sabbath mode certified by Star-K
- Net volume 20.6 cu.ft.

## Operation

TFT touch display operation.  
Clear text display.

## Features

Dynamic cold air distribution.  
Automatic defrosting with defrost water evaporation.  
Cushioned door closing system.  
Activated charcoal air filter.  
Sabbath mode certified by Star-K.  
When sabbath mode is active, the appliance can only be opened using a handle.  
Open-door and malfunction alarm.

Home network integration for digital services (Home Connect) wireless via WiFi. The use of the Home Connect functionality depends on the Home Connect services, which are not available in every country.  
For further information please check: [home-connect.com](http://home-connect.com).

## Cooling

No-Frost technology with fast cooling.  
Temperature adjustable from 35°F to 46°F (+2°C to +8°C).  
4 safety glass shelves, white glass, 3 of which are individually adjustable in height.  
1 shallow, fully extendable drawer with transparent front.  
4 brilliant LED light spots with warm white, glare-free light within cooling area and drawers.  
Flat door rail system with fully flexible positioning of door racks.  
3 height adjustable door racks, 1 of which is extra deep.  
Net volume 20.6 cu.ft.

## Fresh cooling close to 32°F (0°C)

1 large, fully extendable fresh cooling 32°F (0°C) drawer with transparent front, illuminated

Temperature control via central TFT display, temperature can be adjusted from 30°F to 38°F (-1°C to +3°C).  
Ideal for meat, fish and poultry.

## Fresh cooling

1 fully extendable fresh cooling drawer with transparent front, illuminated.  
Cushioned closing system.  
Humidity can be adjusted manually.  
Ideal for fruit and vegetables.

## Consumption data

Energy consumption  
313 kWh/year.  
Noise level 40 dBA.

## Planning notes

Flat hinge.  
Door hinge right, reversible.  
Door opening angle of 115°, fixable at 90°.  
Max. door panel weight: 90 lbs. (41 kg).

Please read additional planning notes on page 242 – 251.

## Rating

Total rating: 0.858 kW/24h.  
Total Amps: 15 A.  
120 V / 60 Hz  
Connecting cable 118" (3m), detachable.

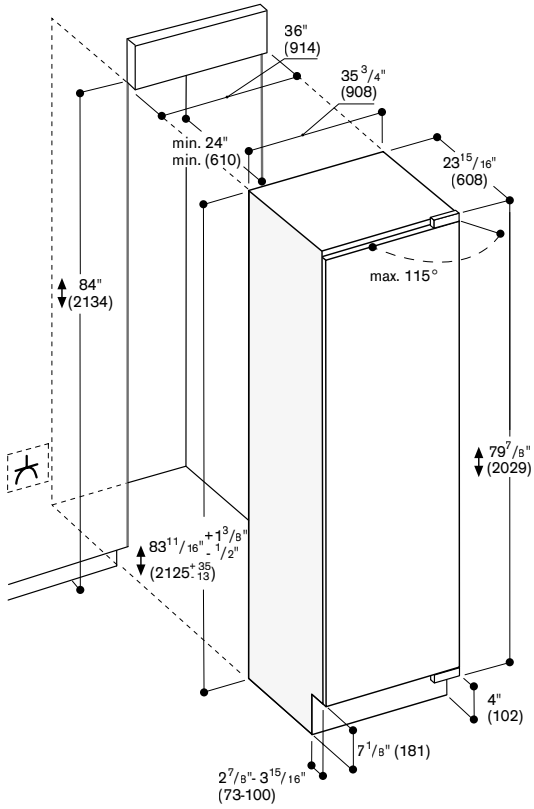

The door face dimensions are designed for a maximum gap of 1/8" (3 mm).  
See more details on page 247.