



Controls on top

Right-hinged

BS 470 611

Stainless steel-backed full glass door
Width 24" (60 cm)

Left-hinged

BS 471 611

Stainless steel-backed full glass door
Width 24" (60 cm)

Included accessories

- 1 Gastronorm pan, unperforated stainless steel, GN ⅔ full tray size
- 1 Gastronorm pan, perforated stainless steel, GN ⅔ full tray size
- 1 wire rack
- 1 core temperature probe
- 1 water inlet hose
- 1 outlet hose (118") on the appliance, interior diameter 1³/₁₆" (the water connection is the same as for the dishwasher)
- 4 cleaning cartridges

Installation accessories

BA 476 310

Optional handle, stainless steel
Length 17 5/8".

GF 111 700

Descaling and neutralizing filter set (complete set for first installation).

GF 121 710

Descaling cartridge (one cartridge only).

GZ 010 011

Aqua stop extension (7.2' long)
Extension for water inlet and outlet.

Optional accessories

CL S10 040

Cleaning cartridges, set of 4
For plumbed Combi-steam ovens.

CL S20 040

Descaling cartridges, set of 4
For plumbed Combi-steam ovens.

GN 114 130

Gastronorm pan, unperforated
Stainless steel
1 1/2" deep, GN 1/2 half tray size.

GN 114 230

Gastronorm pan, unperforated
Stainless steel
1 1/2" deep, GN 3/4 full tray size.

GN 124 130

Gastronorm pan, perforated
Stainless steel
1 1/2" deep, GN 1/2 half tray size.

GN 124 230

Gastronorm pan, perforated
Stainless steel
1 1/2" deep, GN 3/4 full tray size.

GN 144 130

Gastronorm pan, unperforated
Non-stick coating
1 1/2" deep, GN 1/2 half tray size.

400 series Combi-steam oven

BS 470/BS 471

- Handleless door/automatic door opening
- Fresh steam system with water inlet and outlet
- Fully automatic cleaning system
- Convection from 85°F – 450°F at variable humidity levels of 0%, 30%, 60%, 80% or 100%
- Sous-vide cooking with accurate temperature regulation
- 14 cooking modes
- Full surface grill behind glass ceramic for easy cleaning. Can be operated alone, with convection, and humidity up to 450°F
- TFT touch display
- Steaming without pressure
- Electronic precision temperature control from 85°F – 450°F
- Removable core temperature probe
- Net volume 1.7 cu.ft.
- Star-K certified

Cooking modes

Convection + 100 % humidity.
Convection + 80 % humidity.
Convection + 60 % humidity.
Convection + 30 % humidity.
Convection + 0 % humidity.
Low temperature cooking.
Sous-vide cooking.
Broil + convection.
Broil.
Broil level 1 (less intensive) + humidity.
Broil level 2 (more intensive) + humidity.
Defrosting.
Refreshing.
Misting.

Operation

Automatic door opening.
Rotary knobs and TFT touch display operation.
Clear text display in 25 languages.
Option to save 50 individual recipes (incl. core temperature probe).
Information key with use indicators.
Side-opening door opens up to 180° angle.

Features

2000 W full surface grill behind glass ceramic.
Steam evacuation.
Core temperature probe with automatic shut-off function.
Actual temperature display.
Timer functions: cooking time, shut off time, short-term timer, stop watch, Sabbath mode.
Automatic boiling point detection.
Capacity display of filter cartridge (if connected to GF111700 descaling system).
60 W halogen light on the side.
Hygienic stainless steel cooking interior.
Four rack levels.

Safety

Steam evacuation.
Child lock.
Safety lock.
Cooled housing with temperature protection.

Cleaning

Fully automatic cleaning program.
Fully automatic descaling program.

GN 144 230

Gastronorm pan, unperforated
Non-stick coating
1 1/2" deep, GN 3/4 full tray size.

GN 154 130

Gastronorm pan, perforated
Non-stick coating
1 1/2" deep, GN 1/2 half tray size.

GN 154 230

Gastronorm pan, perforated
Non-stick coating
1 1/2" deep, GN 3/4 full tray size.

GN 410 130

Gastronorm lid
Stainless steel
1 1/2" deep, GN 1/2 half tray size.

GN 410 230

Gastronorm lid
Stainless steel
1 1/2" deep, GN 3/4 full tray size.

GR 220 046

Wire rack
Chromium-plated
Without opening, with feet.

GN 340 230

Gastronorm roaster
Non-stick cast aluminum
4" deep, with 2 1/2" lid, GN 3/4.

Drying program.

Grease filter in front of convection fan, dishwasher-safe.
Demo program for automatic cleaning.

Planning notes

Door hinge not reversible.
No other electrical appliances should be installed above the BS Combi-steam oven.
Two 1 1/2"-diameter holes required on rear lower left side for drain and water supply (see also drawing "view from behind" on facing page).
At no point may the drain hose be positioned higher than the bottom edge of the appliance.
The outlet hose must also lie at least 4" lower than the appliance drain (see "waste water" drawing).
The outlet hose must not be longer than a maximum of 17'.
The water connection (1) for the inlet hose must always be accessible and not located directly behind the appliance.
The connection of the outlet hose to the siphon (2) must not be directly behind the appliance and should be accessible.

If the water hardness exceeds 7° dH, GF111700 (3) or another water softening system must be installed when connecting the appliance. (Please contact your plumber for details.)

The front of the appliance extends 1 7/8" from the cabinet front.
When handle (optional accessory) is installed, the outer edge of the door handle extends 3 1/16" from the cabinet front.
Consider the overhang, incl. the door handle, when planning to open drawers next to the appliance.
Plan a gap of at least 3/16" between the appliance and adjacent cabinets.
When planning a corner solution, pay attention to the 90° door opening angle.
To achieve the 21 5/8" installation depth, the hoses and connecting cable need to follow the slanted edge on the lower left hand corner of the housing and then be led down and up, respectively.

The power outlet needs to be planned outside of the niche.
Waste water outlet ø 1 15/16".
Cold water connection (no hot water connection).
Supplied drain and water supply hoses are 9.8' long with 3/4" connection.
Connect supplied drain pipe to a 2" ø hose.

NOTE: Water from reverse osmosis system must never be used.

Please read the installation details regarding air openings on pages 12–13.

Rating

Total rating 3.2 kW.
Total Amps: 13 A.
208/220 – 240 V / 60 Hz
Plan for a 47 1/4" connecting cable without plug (hardwire required).



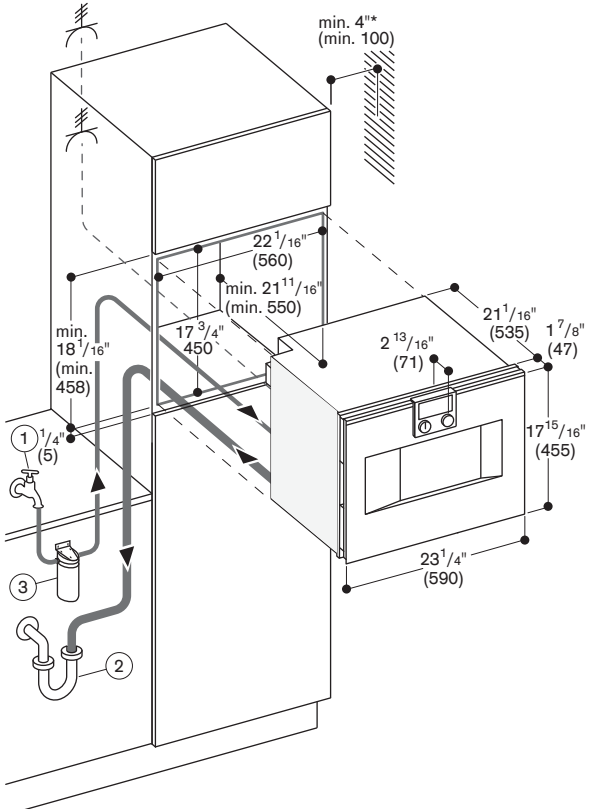

* 8" (200) minimum when installed with handle.

Side view BS 470/471 over BO

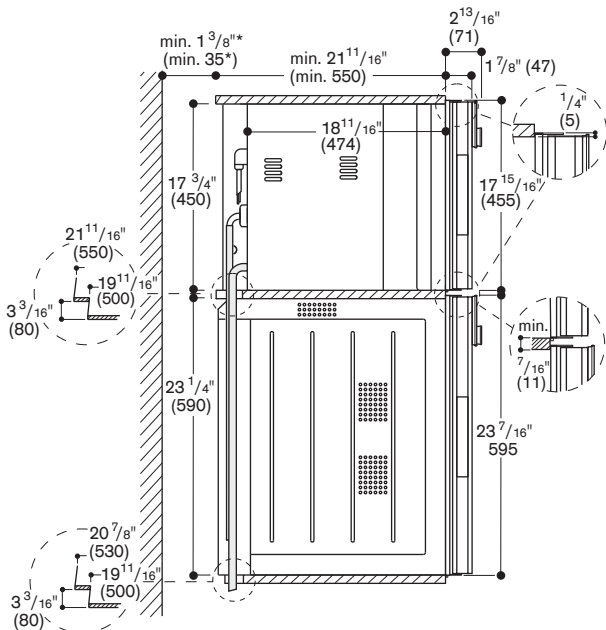

* Only necessary if the water hoses of the BS cannot be fed through the corner openings of the appliances.

Waste water

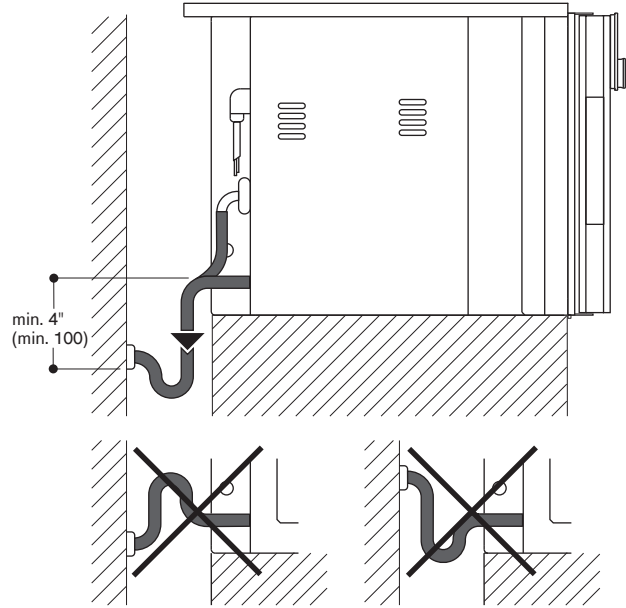

View from behind

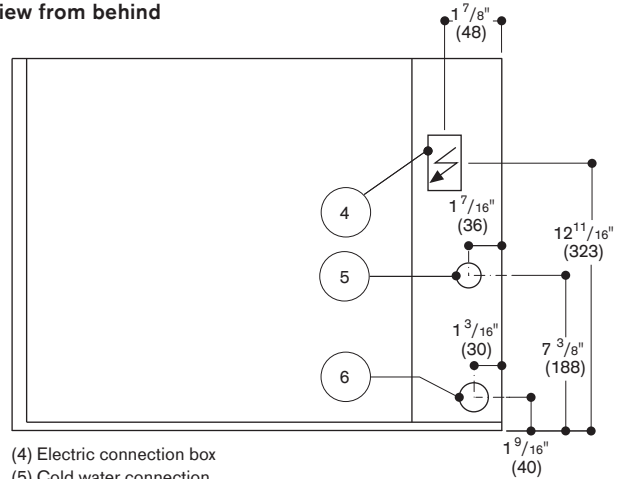

- (4) Electric connection box
- (5) Cold water connection
- (6) Water outlet